



**DATA SHEET DIESEL
GENERATOR SET** 

GSBD21800S-UL



► Model

GSBD21800S-UL

- ENGINE BRAND >> BAUDOUIN
- ENGINE MODEL >> 20M33G2D2/6
- ALTERNATOR BRAND >> STAMFORD
- GENERATOR CONTROLLER >> DSE 7310

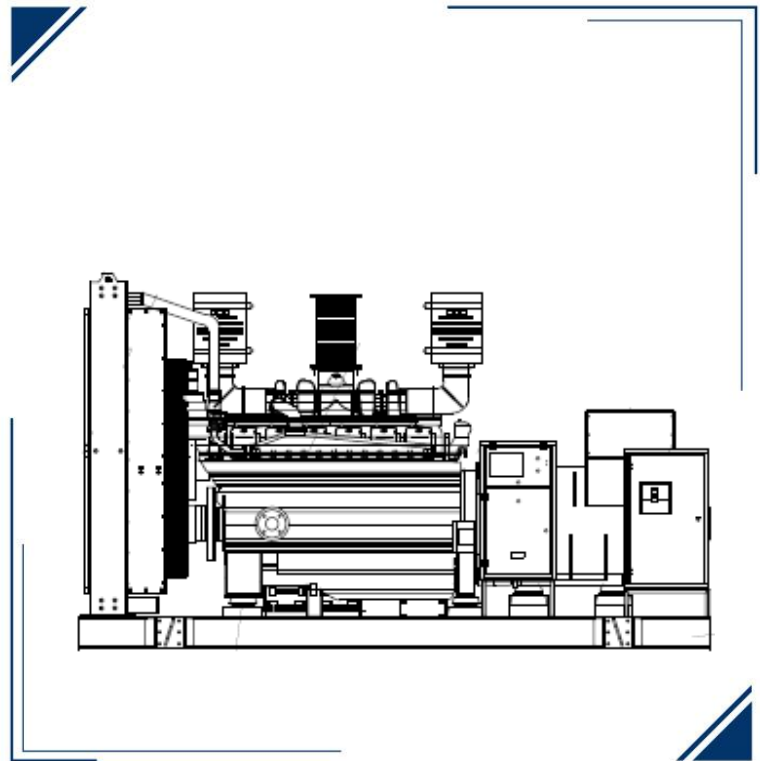

► GENSET RATING

ENGINE	ALTERNATOR	VOLTAGE	PH	Hz	STANDBY POWER		POWER FACTOR	CURRENT
		V			kW	KVA		A
	S7L1D-F4	480/277	3	60	1800	2250	0.8	2709
20M33G2D2/6	S7L1D-F4	600/346	3	60	1800	2250	0.8	2167

► Certifications



Standby Power. Applicable for supplying power to varying electrical load for the duration of power interruption of a reliable utility source. Emergency Standby Power (ESP) is in accordance with ISO 8528. Fuel Stop power in accordance with ISO 3046, AS 2789, DIN 6271 and BS 5514.

► ENGINE FEATURES

» BRAND _____	► BAUDOQUIN
» MODEL _____	► 20M33G2D2/6
» EXHAUST EMISSIONS _____	► TIER 2
» RPM _____	► 1800
» STANDBY RATING kWm _____	► 2027
» STANDBY RATING bhp _____	► 2718
» PRIME RATING kWm _____	► 1840
» PRIME RATING bhp _____	► 2468
» NUMBER OF CYLINDERS _____	► 20
» ASPIRATION _____	► TURBOCHARGED AND AFTERCOOLED
» DISPLACEMENT in ³ _____	► 3991
» ENGINE AIR FLOW CFM (m ³ /min) _____	► 6446.3
» GOVERNOR TYPE _____	► ELECTRONIC
» CONTROL VOLTAGE v _____	► 24
» BORE/STROKE, in (_____	► 5.9X7.2(150X185)
» COOLANT CAPACITY WITHOUT RADIATOR gal _____	► 37
» OIL CAPACITY, TOTAL gal _____	► 62.1

► FUEL CONSUMPTION

STANDBY POWER		
LOAD	GAL/hr	L/hr
100%	136.6	517
75%	97.8	370.1
50%	64.7	244.9
25%	35.3	133.5

► ALTERNATOR FEATURES

» BRAND _____	► STAMFORD
» MODEL _____	► S7L1D-F4
» FREQUENCY _____	► 60 Hz
» PHASES _____	► 3
» WINDING LEADS _____	► 6
» INSULATION SYSTEM _____	► H CLASS
» CONTROL SYSTEM _____	► SEPARATELY EXCITED BY P.M.G.
» PROTECTION _____	► IP23
» POWER FACTOR _____	► 0.8
» COOLING AIR CFM _____	►
» VOLTAGE REGULATION (%) _____	► +-0.5

► GENERATOR CONTROLLER

» MODEL

DEEP SEA 7310

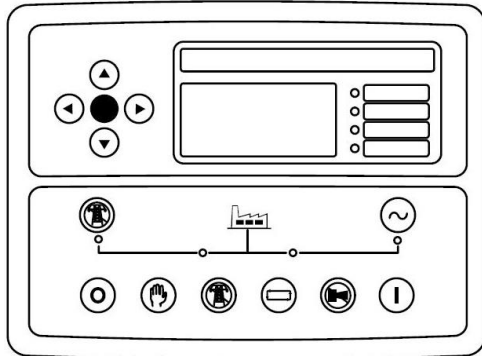

The DSE7310 MKII is an Auto Start Control Module and the DSE7320MKII is an Auto Mains (Utility) Failure Control Module suitable for a wide variety of single, diesel or gas, gen-set applications.

Monitoring an extensive number of engine parameters, the modules will display warnings, shutdown and engine status information on the back-lit LCD screen, illuminated LEDs, remote PC and via SMS text alerts (with external modem). The DSE7320 MKII will also monitor the mains (utility) supply. The modules include USB, RS232 and RS485 ports as well as dedicated DSENet® terminals for system expansion.

KEY FEATURES

- 4-Line back-lit LCD text display
- Multiple Display Languages
- Five key menu navigation
- LCD alarm indication
- DSENet expansion compatibility
- Internal PLC editor
- Protections disable feature
- Fully configurable via PC using USB, RS232 & RS485 communication
- Front panel configuration with PIN protection
- Power save mode
- 3 phase generator sensing and protection
- 3 phase mains (utility) sensing and protection (DSE7320 MKII only)
- Automatic load transfer control (DSE7320 MKII only)
- Generator current and power monitoring (kW, kvar, kVA, pf)
- Mains current and power monitoring (kW, kvar, kVA, pf) (DSE7320 MKII only)
- kW and kvar overload and reverse power alarms

- Over current protection
- Unbalanced load protection
- Independent earth fault protection
- Breaker control via fascia buttons
- Fuel and start outputs configurable when using CAN
- 6 configurable DC outputs
- 2 configurable volt-free relay outputs
- 6 configurable analogue/digital inputs
- Support for 0 V to 10 V & 4 mA to 20 mA sensors
- 8 configurable digital inputs
- Configurable 5 stage dummy load and load shedding outputs
- CAN, MPU and alternator frequency speed sensing in one variant
- Real time clock
- Manual and automatic fuel pump control
- Engine pre-heat and post-heat functions
- Engine run-time scheduler
- Engine idle control for starting & stopping
- Fuel usage monitor and low fuel level alarms
- Simultaneous use of RS232 and RS485 communication ports
- True dual mutual standby using RS232 or RS485 for accurate engine hours balancing.
- MODBUS RTU support with configurable MODBUS pages.
- Advanced SMS messaging (additional external modem required)
- Start & stop capability via SMS messaging
- 3 configurable maintenance alarms
- Compatible with a wide range of CAN engines, including tier 4 engine support

- Uses DSE Configuration Suite PC Software for simplified configuration
- Licence-free PC software
- IP65 rating (with supplied gasket) offers increased resistance to water ingress
- Modules can be integrated into building management systems (BMS) using MODBUS RTU

KEY BENEFITS

- Automatically transfers between mains (utility) and generator (DSE7320 MKII only) for convenience.
- Hours counter provides accurate information for monitoring and maintenance periods
- User-friendly set-up and button layout for ease of use
- Multiple parameters are monitored & displayed simultaneously for full visibility
- The module can be configured to suit a wide range of applications for user flexibility
- PLC editor allows user configurable functions to meet user specific application requirements.

► DIMENSIONS AND WEIGHT

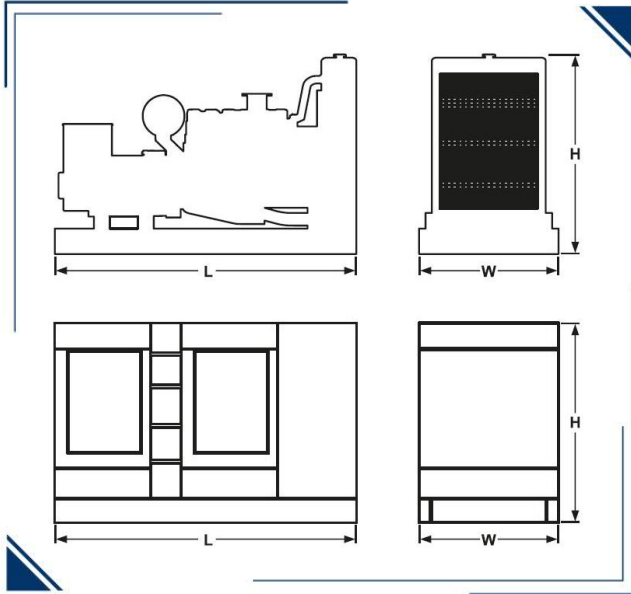

OPEN GENSET					
DIMENSION	Length (L)	Width (W)	Height (H)	Weight	Noise Level
	IN			Lbs	dB
	253	109	130		
ENCLOSED GENSET LEVEL 2					
DIMENSION	Length (L)	Width (W)	Height (H)	Weight	Noise Level
	IN			Lbs	dB
	358	118	144		

► ACOUSTIC ENCLOSURE

Acoustic enclosure designed and manufactured with 14 gauge carbon steel sheet, polyurethane acoustic coating, access and air expulsion to avoid gas accumulation, drainage system to avoid liquid accumulation. Electrostatic painting for extended life. We have options for enclosures in aluminum or stainless steel

► STANDARD FEATURES & ACCESSORIES

<input checked="" type="checkbox"/>	DSE 9470 Battery Charger	<input checked="" type="checkbox"/>	Emergency Stop Button
<input checked="" type="checkbox"/>	Battery and Battery Rack	<input checked="" type="checkbox"/>	Flex Fuel Lines
<input checked="" type="checkbox"/>	ABB Main Line Circuit Breaker	<input checked="" type="checkbox"/>	Protection Covers for Rotating Parts
<input checked="" type="checkbox"/>	MX321AVR	<input checked="" type="checkbox"/>	Exhaust Insulation Cover
<input checked="" type="checkbox"/>	Hotstart Pre heater RMP-CSM10902-000	<input checked="" type="checkbox"/>	Anti Vibration Pads between Engine/Alternator & Base Frame
<input checked="" type="checkbox"/>	Residential Grade Silencer Open Unit	<input checked="" type="checkbox"/>	Operation and Maintenance manuals
<input checked="" type="checkbox"/>	Critical Grade Silencer Inside Enclosure	<input checked="" type="checkbox"/>	24 Months /1000 hours Limited Standby Warranty



▶ OPTIONAL ACCESSORIES

Paralleling Adder (DSE8610 & Motorized Breaker)	Enclosure AC light and On/Off Switch
120V GFCI Receptacle	Enclosure DC light and On/Off Switch
240V Receptacle	Enclosure space Heater (1500w/120v)
Alternator Strip Heater	Load Center / Distribution Board (100 A, 12 Breaker)
Battery Blanket Heater	Load Center / Distribution Board (200 A, 8 Breaker)
Battery Disconnect Switch	AVR UPGRADE
Battery Pad Heater	Oil Pan Heater
Battery Restraint	Relay - 10A Common Alarm
Control Panel Heater	Relay - 10A Run Relay
DSE2157 Output Module (8 dry contacts)	Remote E-Stop- Breaker Glass Type / Nema 3R
DSE2520 Remote Display Module	Remote E-Stop- Breaker Glass Type / Nema 4X
DSE2548 Remote Annunciator (16 light)	Remote E-Stop- Flush Mount
DSE2548 Remote Annunciator (24 light)	Remote E-Stop- Surface Mount
DSE2548 Remote Annunciator (8 light)	Remote E-Stop- Visual/ Plastic Hinged Cover
DSE890 3G GATEWAY	Spring Isolator- Non Seismic (ACE 121 Series) <small>SKIRT NOT INCLUDED</small>
GSM/GPS ANTENNA 3M RG-174, GSM-SMA(M), GPS-SMA(F)	Spring Isolator- Seismic/Restraint (ACE 821 Series) <small>SKIRT NOT INCLUDED</small>
DSE9641 10A Battery Charger	Voltage Adjust Rheostat
DSE9470 10A Battery Charger	Automatic Transfer Switch

▶ OPTIONAL UL142 SUB BASE TANK

	24 hr	48 hr	72 hr
Fuel Capacity (gal)	3700	7500	
Dimensions (L/W/H) in			
Weight lb			



IGSA CORP.
5918 Santa Ave
Laredo, Texas 78041
Tel. +1 956.7914.472

www.igsapower.com



	Model :	20M33G2D2/6	Date :	30/11/22
	PowerKit Engine Datasheet		Page :	1 / 4

Ratings

RPM	Gross Engine Output				Net Engine Output			
	PRP		ESP		PRP		ESP	
	kWm	BHP	kWm	BHP	kWm	BHP	kWm	BHP
1800	1840 *	2468 *	2027	2718	1758 *	2358 *	1945	2609

1 kWm = 1,34102 BHP

When the engine is used with a cooling system using an electrically driven fan, net engine output data may change and quoted figures should be used for reference only

Basic data

Engine model	20M33G2D2/6
N° of Cylinders / Valves	20 / 80
Cylinders arrangement	At Vee
Bore x Stroke (mm)	150 x 185
Displacement (L)	65.4
Thermodynamic Cycle	Diesel 4 stroke
Firing Order	A1-B7-A2-B5-A4-B3-A6-B1-A8-B2-A10-B4-A9-B6-A7-B8-A5-B10-A3-B9
Mean Piston Speed (m/s)	11.1
BMEP @ ESP (Bar)	20.66
Cooling System	Liquid (water + 50% antifreeze)
Injection System	Direct
Fuel System	High Pressure Common Rail
Aspiration	Turbocharged and Aftercooled
Compression ratio	15 : 1
Flywheel housing	SAE 00
Flywheel	21"
Rotation Viewed from Flywheel...	Counterclockwise
Allowed static bending moment of the flywheel housing.....	/
N° of teeth on flywheel ring gear	159
Inertia of flywheel (kg•m ²)	8.64
Inertia of crankshaft (kg•m ²)	16.24
Emission standard	EPA Tier2
Overall Dimensions with radiator (Length x Width x Height) (mm)	4611×2756×2870
Engine dry weight without radiator and without radiator pipes (kg)	6650
Engine dry weight with radiator and radiator pipes (kg)	8275
Engine wet weight with radiator (includes oil, coolant) (kg)	8899

* The indicated PRP Power is for reference only. This engine is designed for emergency standby power (ESP) applications only.

	Model :	20M33G2D2/6	Date :	30/11/22
	PowerKit Engine Datasheet		Page :	2 / 4

Air intake system

Air intake temperature rise (°C)	≤ 5
Air intake restriction clean filter (mBar)	≤ 30
Air intake restriction dirty filter (mBar)	≤ 75
Recommended air flow @ PRP (m³/min)	173.5
Recommended air flow @ ESP (m³/min)	182.2
Min. diameter of intake pipe (mm)	140

Aftercooling system

Aftercooler system type	Air to Water
Max. intake temperature @ 25°C ambient temperature (°C)	55
Max. difference between intake temperature and ambient temperature (°C)	30
Max. intake pressure drop of aftercooler (mBar)	80

Lubrication system

Oil capacity Low / High (L)	210/240
Oil pressure in normal condition idle speed (Bar)	≥ 2
Oil pressure in normal condition at 1800 Rpm @ PRP (Bar)	4 - 6.5
Lowest oil pressure alarm (shutdown) (Bar)	2
High Oil Pressure Warning	10
Max. oil temperature (°C)	105
Oil flow at 1800 Rpm (L/min)	≥ 640
Oil fuel consumption ratio based on engine fuel consumption data	≤ 0.3 %
Total system capacity (including filters) (L)	235

Heat balance test data (with ambient temperature 21 °C)

Total heat dissipation @ ESP (kJ/s)	3530.0
- Heat Rejection to Jacket Water @ ESP (kJ/s)	843.5
- Heat Rejection to Low temperature circuit @ ESP (kJ/s)	578.2
- Radiated Heat to Ambient @ ESP (kJ/s)	268.2
- Heat Rejected to Exhaust @ ESP (kJ/s)	1840.1

Exhaust system

Max. exhaust back pressure (mBar)	75
Max. exhaust temperature before turbocharger (°C)	750
Max. exhaust temperature after turbocharger (°C)	550
Exhaust flow @ PRP (m³/min)	557.9
Exhaust flow @ ESP (m³/min)	565.7
Min. diameter of exhaust pipe (mm)	200
Max. bending moment of exhaust gas exit flange (Nm)	10

	Model :	20M33G2D2/6	Date :	30/11/22
	PowerKit Engine Datasheet		Page :	3 / 4

Cooling system with standard radiator

System designed for ambient temperature up to (°C) ¹	50
Radiator type	Mechanical
Fan type	Belt driven pusher
Min. inside diameter of coolant outlet pipe (mm)	100
Coolant capacity of radiator and pipes (L)	270
Coolant alarm (shutdown) temperature (°C)	108
Thermostat opening temperature / full open temperature (°C)	80 / 92
Max. additional restriction for external cooling circuit (Bar)	0.34
Coolant capacity of the engine (L)	140
Cooling fan airflow (m ³ /min)*	3480
Fan absorbed power (kW)	80
Additional restriction (for reference) - Duct allowance (Pa)	150

* Air flow figure assumes the presence of the standard radiator provided, taking into consideration the backpressure caused

Fuel system

Governor	ECU
Governor steady state speed stability at constant load (ISO 8528-5 Class G3) ²	≤ +/- 0.5 %
Max. restriction at fuel inlet (Bar)	0.5
Max. pressure at fuel inlet (Bar)	0.5
Max. fuel return restriction (Bar)	0.2
Max. fuel inlet temperature (°C)	50
Fuel supply flow (L/hr)	2900
Min. internal diameter of inlet pipe (mm)	19
Min. internal diameter of return pipe (mm)	19

Electrical system

Electrical system voltage (negative to ground) (Vdc)	24
Starter power (kW)	2 x 10
Battery charger current (A)	55
Battery charger absorbed power (kW)	1.6
Max. electric resistance of starting circuit (Ω)	0.008
Min. sectional area of wire (mm ²)	95
Min. cold start temperature without auxiliary starting device (°C) ³	- 10
Min. cold start temperature with auxiliary starting device (°C) ³	- 25

¹ The indicated value is based on the AOT value of 50°C for an engine tested at 100% of the ESP Power, reflecting temperature in an open condition, without an enclosure or container, without any airflow obstruction in the front of the radiator, without air recirculation, with free exhaust gas exit and with the engine thermostatic valve in its full open condition, without a closing plate present. The reference air restriction is equal to 50Pa. For the equivalent ATB (Air-to-Boil) performance in a customer or project basis, please consult Baudouin Application Engineering.

² This refers only to the frequency response of the engine and should not be confused with the performance class of the Generator Set, which is subject to additional contributing factors such as alternator selection and control settings.

³ Engines used in emergency standby application or applications that require immediate start under load, they must be equipped with coolant heaters. Baudouin recommend heaters installation to be executed by providing constant coolant circulation across all the engine components. Two heaters are required for V-type engines, one per each side.

	Model : 20M33G2D2/6	Date : 30/11/22
	PowerKit Engine Datasheet	Page : 4 / 4

Noise

Diesel engine noise (Acoustic power level) (dB(A))	105.2
Noise - upper side (dB(A))	102.6
Noise - right side (view from flywheel) (dB(A))	103.7
Noise - left side (view from flywheel) (dB(A))	100.9
Noise – front (radiator) side (dB(A))	102.2
Noise – rear (flywheel) side (dB(A))	121.3

Notes :

- Noise test made at 100% of the ESP power, at 1 mt. distance, on engine without radiator, without cooling fan and without silencer.
- Noise test refers to ISO 6798 norm : “Reciprocating internal combustion engines. Measurement of emitted airborne noise. Engineering method and survey method”.

Fuel consumption

Rating	gr/kWh	L/hr
100% ESP	214.2	517.0
100% PRP	220.0	478.0
75% PRP	225.3	370.1
50% PRP	223.6	244.9
25% PRP	243.8	133.5
Fuel consumption tolerance +/- 5%		

Notes:

This engine is designed for ESP (Emergency Standby) applications only, the values shown above at PRP levels refer to the Referenced Power (1840 kWm).

Ratings definitions

Emergency Standby Power (ESP)

Emergency Standby Power is the maximum power available for a varying load for the duration of a main power network failure. The average load factor over 24 hours of operation should not exceed 70% of the engine’s ESP power rating. Typical operational hours of the engine is 200 hours per year, with a maximum usage of 500 hours per year. This includes an annual maximum of 25 hours per year at the ESP power rating. No overload capability is allowed. The engine is not to be used for sustained utility paralleling applications.

Prime Power (PRP)

Prime Power is the maximum power available for unlimited hours of usage in a variable load application. The average load factor should not exceed 70% of the engine’s PRP power rating during any 24 hour period. An overload capability of 10% is available, however, this is limited to 1 hour within every 12 hour period.

- All ratings are based on operating conditions under ISO 8528-1, ISO 3046, DIN6271. Performance tolerance of $\pm 5\%$.
- Test conditions : 100 kPa, 25°C air inlet temperature, relative humidity of 30%, with fuel density 0.84 kg/L. Derating may be required for conditions outside these; please contact the factory for details.
- Power output curves are based on the engine operating with fuel system, water pump and lubricating oil pump; not included are battery charging alternator, fan and optional equipment.

STAMFORD®

S7L1D-F4 Wdg.07 - Technical Data Sheet

Standards

STAMFORD industrial alternators meet the requirements of the relevant parts of the IEC EN 60034 and the relevant section of other international standards such as BS5000, VDE 0530, NEMA MG1-32, IEC34, CSA C22.2-100 and AS1359. Other standards and certifications can be considered on request.

Quality Assurance

Alternators are manufactured using production procedures having a quality assurance level to BS EN ISO 9001.

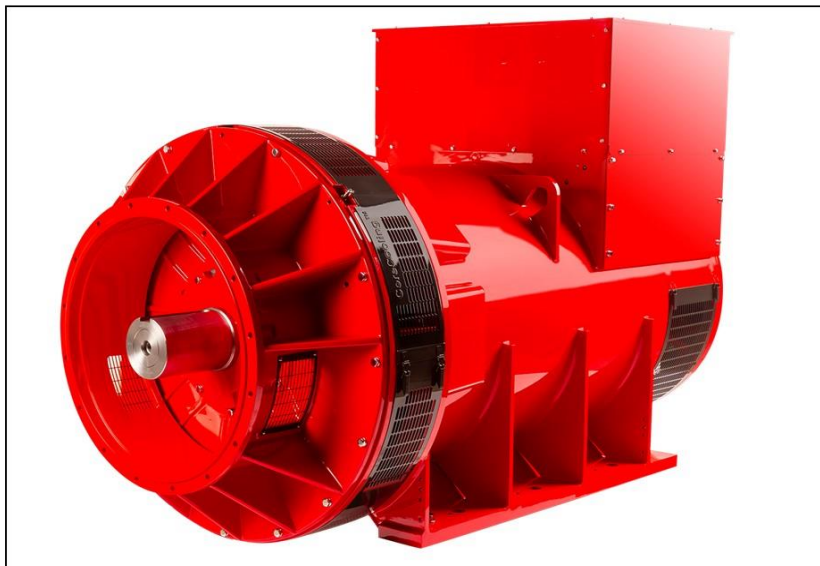

Excitation and Voltage Regulators

Excitation System					
AVR Type	MX341	MX322	DECS100	DECS150	
Voltage Regulation	± 1%	± 0.5%	± 0.25%	± 0.25%	with 4% Engine Governing
AVR Power	PMG	PMG	PMG	PMG	

No Load Excitation Voltage (V)	18.56
No Load Excitation Current (A)	0.83
Full Load Excitation Voltage (V)	63
Full Load Excitation Current (A)	2.8
Exciter Time Constant (seconds)	0.125

STAMFORD®

S7L1D-F4 Wdg.07

Electrical Data	
Insulation System	H
Stator Winding	Double Layer Concentric
Winding Pitch	2/3
Winding Leads	6
Winding Number	07
Number of Poles	4
IP Rating	IP23
RFI Suppression	BS EN 61000-6-2 & BS EN 61000-6-4, VDE 0875G, VDE 0875N. Refer to factory for others
Waveform Distortion	NO LOAD < 1.5% NON-DISTORTING BALANCED LINEAR LOAD < 5.0%
Short Circuit Ratio	1/Xd
Steady State X/R Ratio	32.07
60 Hz	
Telephone Interference	TIF<50
Cooling Air Flow	3.02 m³/sec
Voltage Star (V)	600
Voltage Parallel Star (V)	-
Voltage Delta (V)	-
kVA Base Rating (Class H) for Reactance Values (kVA)	2300
Saturated Values in Per Unit at Base Ratings and Voltages	
Xd Dir. Axis Synchronous	2.60
X'd Dir. Axis Transient	0.20
X''d Dir. Axis Subtransient	0.14
Xq Quad. Axis Reactance	1.91
X''q Quad. Axis Subtransient	0.22
XL Stator Leakage Reactance	0.08
X2 Negative Sequence Reactance	0.17
X0 Zero Sequence Reactance	0.03
Unsaturated Values in Per Unit at Base Ratings and Voltages	
Xd Dir. Axis Synchronous	3.12
X'd Dir. Axis Transient	0.23
X''d Dir. Axis Subtransient	0.16
Xq Quad. Axis Reactance	1.97
X''q Quad. Axis Subtransient	0.26
XL Stator Leakage Reactance	0.09
Xlr Rotor Leakage Reactance	0.20
X2 Negative Sequence Reactance	0.21
X0 Zero Sequence Reactance	0.04

STAMFORD

S7L1D-F4 Wdg.07

Time Constants (Seconds)		
T'd Transient Time Const.	0.141	
T''d Sub-Transient Time Const.	0.016	
T'do O.C. Field Time Const.	4.420	
Ta Armature Time Const.	0.040	
T''q Sub-Transient Time Const.	0.0100	
Resistances in Ohms (Ω) at 22°C		
Stator Winding Resistance (Ra), per phase for series connected	0.00131	
Rotor Winding Resistance (Rf)	1.95	
Exciter Stator Winding Resistance	22.3	
Exciter Rotor Winding Resistance per phase	0.065	
PMG Phase Resistance (Rpmg) per phase	1.91	
Positive Sequence Resistance (R1)	0.0016	
Negative Sequence Resistance (R2)	0.0019	
Zero Sequence Resistance (R0)	0.0016	
Saturation Factors	600V	
SG1.0	0.271	
SG1.2	2.149	
Mechanical Data		
Shaft and Keys	All alternator rotors are dynamically balanced to better than BS6861: Part 1 Grade 2.5 for minimum vibration in operation. Two bearing generators are balanced with a half key.	
	1 Bearing	2 Bearing
SAE Adaptor	SAE0, SAE00	SAE0, SAE00
Moment of Inertia	40.98 kgm ²	40.08 kgm ²
Weight Wound Stator	1518kg	1518kg
Weight Wound Rotor	1353kg	1300kg
Weight Complete Alternator	3350kg	3264kg
Shipping weight in a Crate	3399kg	3313kg
Packing Crate Size	200 x 105 x 155(cm)	200 x 105 x 155(cm)
Maximum Over Speed	2250 RPM for two minutes	
Bearing Drive End	-	BALL. 6228 C3
Bearing Non-Drive End	BALL. 6319 C3	BALL. 6319 C3

STAMFORD®

S7L1D-F4 Wdg.07

THREE PHASE EFFICIENCY CURVES

60Hz

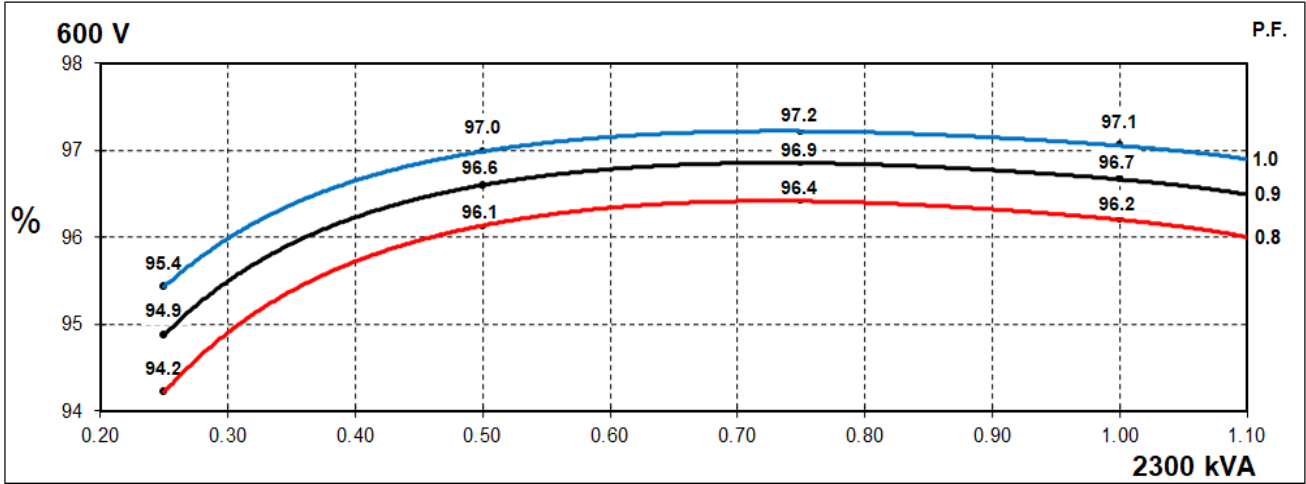

STAMFORD

S7L1D-F4 Wdg.07

Locked Rotor Motor Starting Curves - Separately Excited

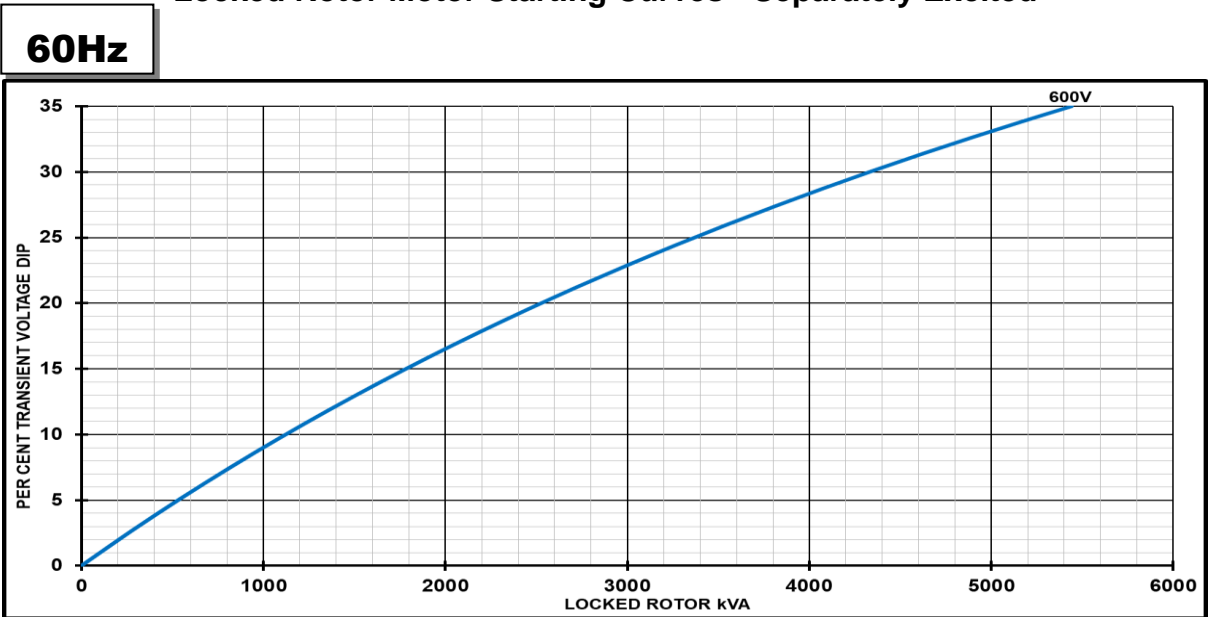

Transient Voltage Dip Scaling Factor		Transient Voltage Rise Scaling Factor	
Lagging PF	Scaling Factor	Lagging PF	Scaling Factor
<= 0.4	1.00	<= 0.4	1.25
0.5	0.95	0.5	1.20
0.6	0.90	0.6	1.15
0.7	0.86	0.7	1.10
0.8	0.83	> 0.7	1.00
0.9	0.75		
0.95	0.70		
1	0.65		

Note: To determine % Transient Voltage Dip or Voltage Rise at various PF, multiply the % Voltage Dip from the curve directly by the Scaling Factor.

STAMFORD®

S7L1D-F4 Wdg.07

Three-phase Short Circuit Decrement Curve - Separately Excited

60Hz

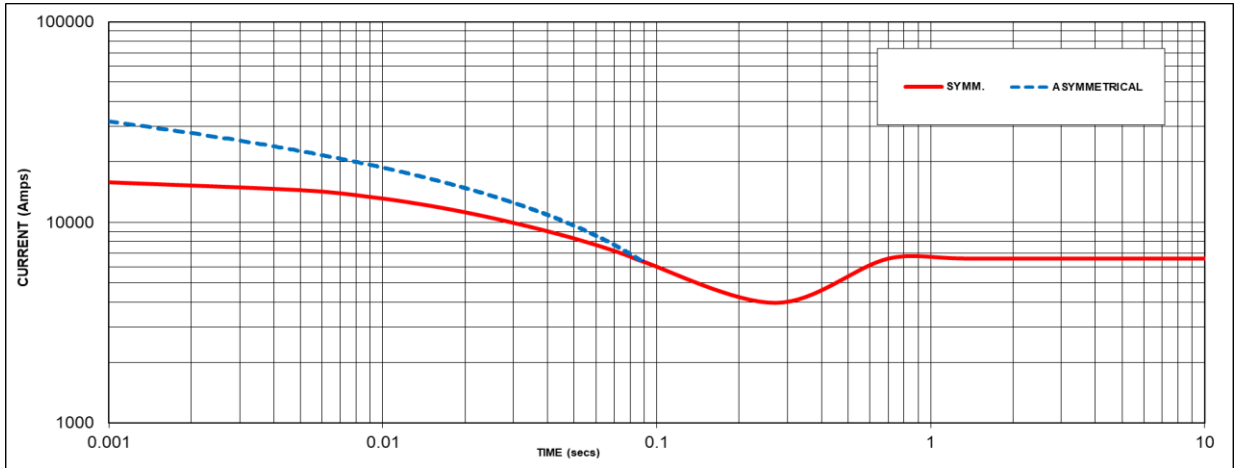

Sustained Short Circuit = 6597 Amps

Note 1

The following multiplication factors should be used to adjust the values from curve between time 0.001 seconds and the minimum current point in respect of nominal operating voltage :

50Hz		60Hz	
Voltage	Factor	Voltage	Factor
-	-	600V	x 1.00
-	-	-	-
-	-	-	-
-	-	-	-

The sustained current value is constant irrespective of voltage level

Note 2

The sustained current values are for MX341 AVR. For MX322 and Digital AVR 1.2 factor to be applied to the sustained short circuit

Note 3

The following multiplication factor should be used to convert the values calculated in accordance with NOTE 1 to those applicable to the various types of short circuit :

	3-phase	2-phase L-L	1-phase L-N
Instantaneous	x 1.00	x 0.87	x 1.30
Minimum	x 1.00	x 1.80	x 3.20
Sustained	x 1.00	x 1.50	x 2.50
Max. sustained duration	10 sec.	5 sec.	2 sec.

All other times are unchanged

Note 4

Curves are drawn for Star connections under no-load excitation at rated speeds. For other connection (where applicable) the following multipliers should be applied to current values as shown :

Parallel Star = Curve current value X 2

Series Delta = Curve current value X 1.732

STAMFORD®

S7L1D-F4 Wdg.07

Typical Alternator Operating Charts

600V/60Hz

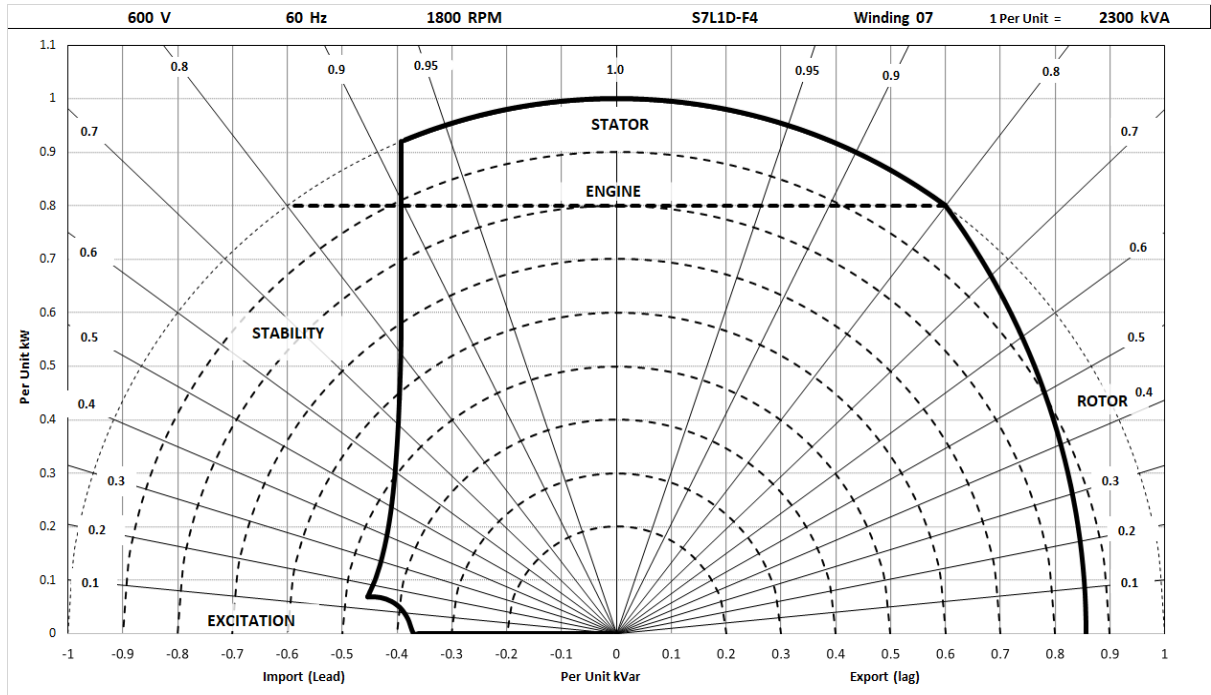

STAMFORD®

S7L1D-F4 Wdg.07

RATINGS AT 0.8 POWER FACTOR

Class - Temp Rise		Standby - 163/27°C	Standby - 150/40°C	Cont. H - 125/40°C	Cont. F - 105/40°C
50 Hz	Star (V)	N/A	N/A	N/A	N/A
	Parallel Star (V)	N/A	N/A	N/A	N/A
	Delta (V)	N/A	N/A	N/A	N/A
	kVA	N/A	N/A	N/A	N/A
	kW	N/A	N/A	N/A	N/A
	Efficiency (%)	N/A	N/A	N/A	N/A
	kW Input	N/A	N/A	N/A	N/A

60 Hz	Star (V)	600	600	600	600
	Parallel Star (V)	N/A	N/A	N/A	N/A
	Delta (V)	N/A	N/A	N/A	N/A
	kVA	2469	2400	2300	2144
	kW	1975	1920	1840	1715
	Efficiency (%)	96.1	96.1	96.2	96.3
	kW Input	2056	1997	1913	1781

De-rates

All values tabulated above are subject to the following reductions:

- 5% when air inlet filters are fitted
- 3% for every 500 meters by which the operating altitude exceeds 1000 meters above mean sea level
- 3% for every 5°C by which the operational ambient temperature exceeds 40°C @ Class H temperature rise (please refer to applications for ambient temperature de-rates at other temperature rise classes)
- For any other operating conditions impacting the cooling circuit please refer to applications

Note: Requirement for operating in an ambient exceeding 60°C and altitude exceeding 4000 meters (for <690V) or 1500 meters (for >690V) must be referred to applications.

Dimensional and Torsional Drawing

For dimensional and torsional information please refer to the alternator General Arrangement and rotor drawings available on our website (<http://stamford-avk.com/>)

Note: Continuous development of our products means that the information contained in our data sheets can change without notice, and specifications should always be confirmed with Cummins Generator Technologies prior to purchase.



Follow us @stamfordavk



Cummins Generator Technologies



View our videos at youtube.com/stamfordavk

news.stamford-avk.com

**For Applications Support:
applications@cummins.com**

**For Customer Service:
emea.service@cummins.com**

**For General Enquiries:
Stamford-avk@cummins.com**

Copyright 2016. Cummins Generator Technologies Ltd. All rights reserved.
Cummins and the Cummins logo are registered trade marks of Cummins Inc.
STAMFORD is a registered trade mark of Cummins Generator Technologies Ltd.



SYMBOLS CONTROL
 INSPECTION DIMENSION
 DRAWING REVISION

*NOTE: LOCATIONS OF COOLANT HEATER AND BATTERIES ARE DIFFERENT FOR EACH ENGINE MODEL

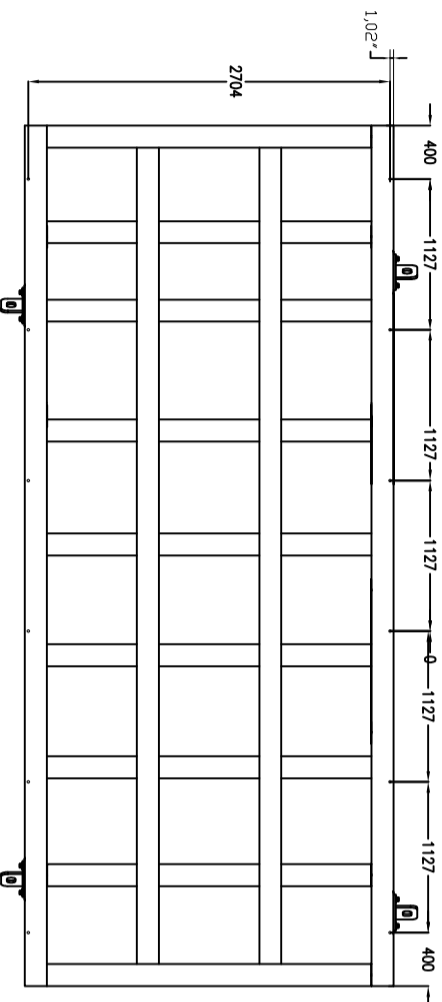
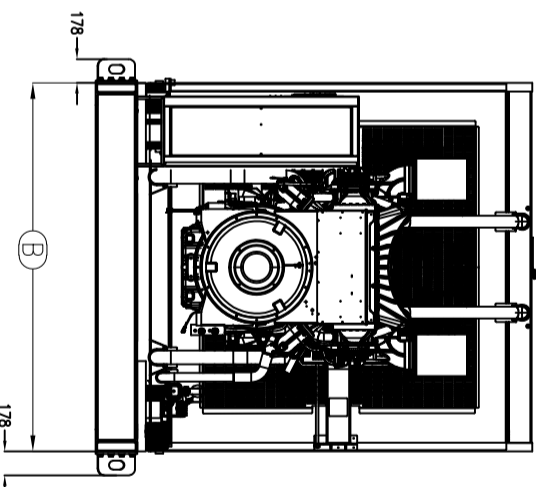
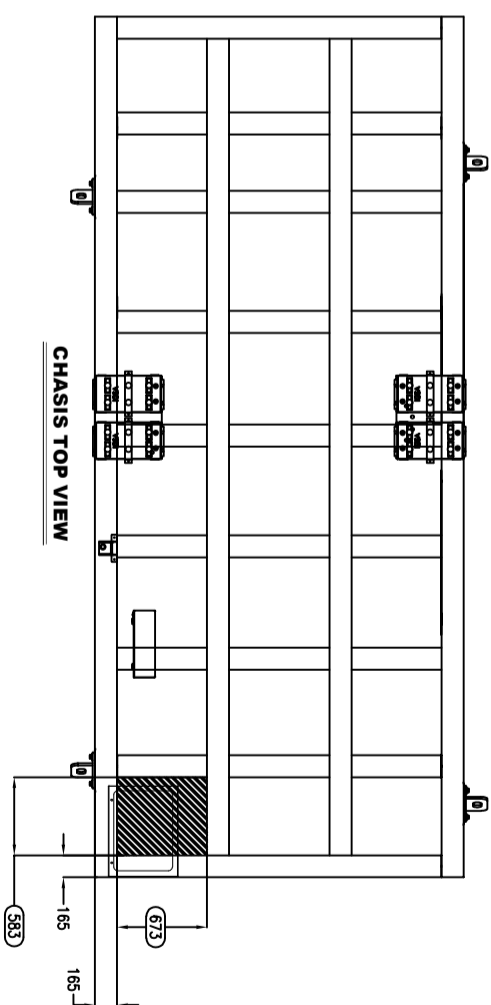
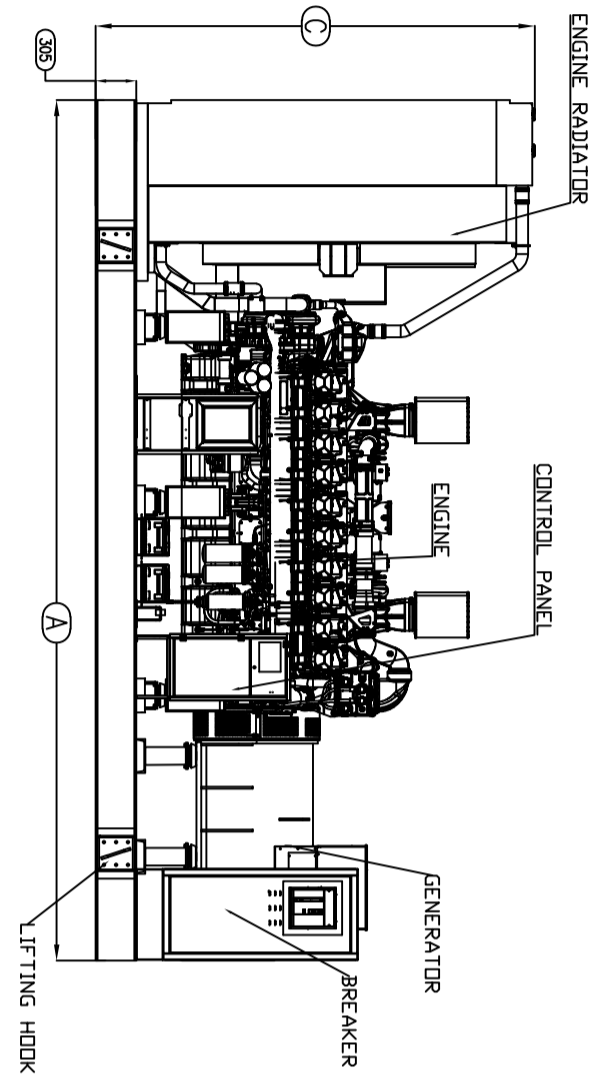
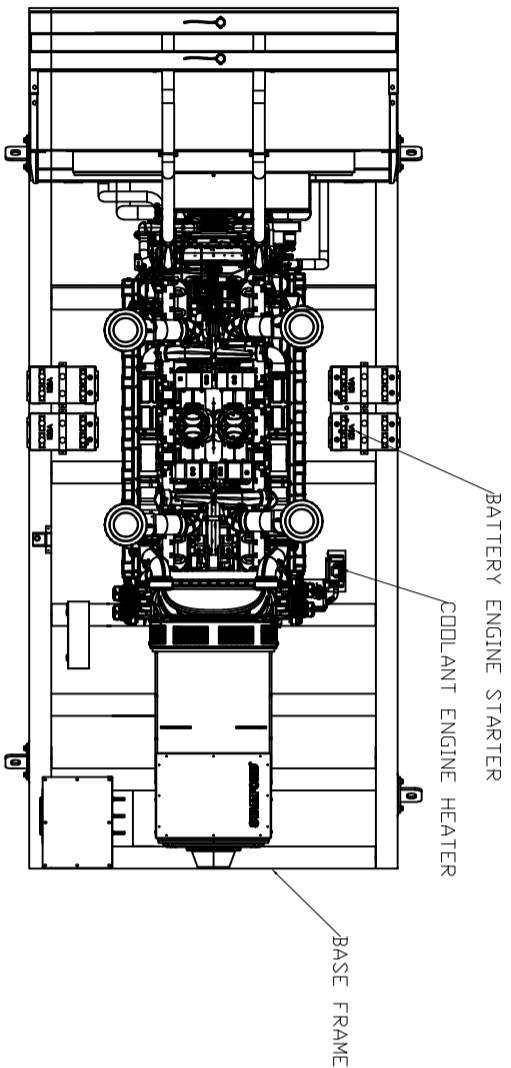

PART TOLERANCES TABLE		NON SPECIFIED TOLERANCES	
INTERVAL	TOLERANCE	GENERAL TOLERANCES	FINISH
0" - 40"	± 0.004"	BURRS	MODULAR
40" - 165"	± 0.005"	SLOTT	± 0.005"
165" - 3282"	± 0.006"	100% TOLERANCE	
40" - 3282"	± 0.007"		
MATERIAL		ITEM	WEIGHT (kg)
NA			NA
			CLEAN SURFACES FREE OF BURRS

OVERALL DIMENSIONS TABLE OF ACOUSTIC CABIN		
	MINIMUM SIZE	MAXIMUM SIZE
A (LENGTH)	6433	6933
B (WIDE)	2756	3256
C (HIGH)	3282	3782

DEPT:	ENGINEERING	DATE:	17-08-2023	DRAWING:	MBS	REVISED:	DLM	APPROVED:	
SCALE:	1:1	CUSTOMER:	STD	DRAWING No/EG	WD/C	BD	1800-2000 KW	REV:	00
TITLE:	CHASSIS FOR 1800-2000 KW BAUDOUIN ENGINE								
	SHEET 1 OF 1								

IGSA S.A. DE C.V.
 DEPT. GENERAL MGT. DE RECURSOS HUMANOS, CALLE 277, ZONA INDUSTRIAL, GUAYMAS, SONORA, MEX.
 ENGINEERING DEPARTMENT. TEL: 52-562-288-3800 FAX: 562-288-3800

HE INFORMATION CONTAINED HEREIN IS EXCLUSIVE PROPERTY OF IGS S.A. DE C.V.
 THEREFORE, IT CAN NOT BE USED, COPIED OR REPRODUCED WITHOUT THE WRITTEN CONSENT OF IGS S.A. DE C.V.

CERTIFICATE OF COMPLIANCE

Certificate Number UL-US-2345744-0
Report Reference AU6440-20231107
Date 10-Nov-2023

Issued to: IGSA S A DE C V
PROLONGACION PASEO DE LA REFORMA # 2977
COL CUAJIMALPA
MEXICO, Mexico 05000
Mexico

This is to certify that representative samples of FTSR - Engine Generators
See Addendum Page for Product Designation(s).

Have been evaluated by UL in accordance with the Standard(s) indicated on this Certificate.

Standard(s) for Safety: UL 2200, 2nd Ed., Issue Date: 2012-06-01, Revision Date: 2015-07-29

Additional Information: See the UL Online Certifications Directory at <https://iq.ulprospector.com> for additional information

This Certificate of Compliance indicates that representative samples of the product described in the certification report have met the requirements for UL certification. It does not provide authorization to apply the UL Mark. Only the Authorization Page that references the Follow-Up Services Procedure for ongoing surveillance provides authorization to apply the UL Mark.

Only those products bearing the UL Mark should be considered as being UL Certified and covered under UL's Follow-Up Services.

Look for the UL Certification Mark on the product.

Deborah Jennings-Conner

Deborah Jennings-Conner, VP Regulatory Services

UL LLC

Any information and documentation involving UL Mark services are provided on behalf of UL LLC (UL) or any authorized licensee of UL. For questions, please contact a local UL Customer Service Representative at <http://ul.com/aboutul/locations/>



CERTIFICATE OF COMPLIANCE

Certificate Number UL-US-2345744-0
Report Reference AU6440-20231107
Date 10-Nov-2023

This is to certify that representative samples of the product as specified on this certificate were tested according to the current UL requirements

Model	Category Description
GSBD00700S, GSBD00700L, GSBD00700LT GSBD00700W	Engine Generators
GSBD00800S, GSBD00800L, GSBD00800LT GSBD00800W	Engine Generators
GSBD01000S, GSBD01000L, GSBD01000W	Engine Generators
GSBD01300S, GSBD01300L, GSBD01300W	Engine Generators
GSBD01500S, GSBD01500L, GSBD01500W	Engine Generators
GSBD01700S, GSBD01700L, GSBD01700W, GSBD01750S, GSBD01750L	Engine Generators
GSBD01800S, GSBD01800L	Engine Generators
GSBD02000S, GSBD02000L	Engine Generators
GSBD02300S, GSBD02300L	Engine Generators
GSBD02500S, GSBD02500L	Engine Generators
GSBD02640S, GSBD02640L	Engine Generators
GSBD02800S, GSBD02800L	Engine Generators
GSBD03000S, GSBD03000L	Engine Generators
GSBD03300S, GSBD03300L	Engine Generators
GSBD30600S, GSBD30600L, GSBD30600LT GSBD30600W	Engine Generators
GSBD30633S, GSBD30633L, GSBD30633LT GSBD30633W	Engine Generators
GSBD30644S, GSBD30644L, GSBD30644LT GSBD30644W	Engine Generators

Deborah Jennings-Conner
Deborah Jennings-Conner, VP Regulatory Services



UL LLC

Any information and documentation involving UL Mark services are provided on behalf of UL LLC (UL) or any authorized licensee of UL. For questions, please contact a local UL Customer Service Representative at <http://ul.com/aboutul/locations/>

CERTIFICATE OF COMPLIANCE

Certificate Number UL-CA-2339551-0
Report Reference AU6440-20231107
Date 10-Nov-2023

Issued to: IGSA S A DE C V
PROLONGACION PASEO DE LA REFORMA # 2977
COL CUAJIMALPA
MEXICO, Mexico 05000
Mexico

This is to certify that representative samples of FTSR7 - Engine Generators Certified for Canada
See Addendum Page for Product Designation(s).

Have been evaluated by UL in accordance with the Standard(s) indicated on this Certificate.

Standard(s) for Safety: CSA C22.2 No. 14, Edition 13, Issue Date 2018-03, Revision Date 2022-06

Additional Information: See the UL Online Certifications Directory at <https://iq.ulprospector.com> for additional information

This Certificate of Compliance indicates that representative samples of the product described in the certification report have met the requirements for UL certification. It does not provide authorization to apply the UL Mark. Only the Authorization Page that references the Follow-Up Services Procedure for ongoing surveillance provides authorization to apply the UL Mark.

Only those products bearing the UL Mark should be considered as being UL Certified and covered under UL's Follow-Up Services.

Look for the UL Certification Mark on the product.

Deborah Jennings-Conner, VP Regulatory Services

UL LLC



Any information and documentation involving UL Mark services are provided on behalf of UL LLC (UL) or any authorized licensee of UL. For questions, please contact a local UL Customer Service Representative at <http://ul.com/aboutul/locations/>

CERTIFICATE OF COMPLIANCE

Certificate Number UL-CA-2339551-0
Report Reference AU6440-20231107
Date 10-Nov-2023

This is to certify that representative samples of the product as specified on this certificate were tested according to the current UL requirements

Model	Category Description
GSBD00700S, GSBD00700L, GSBD00700LT GSBD00700W	Engine Generators
GSBD00800S, GSBD00800L, GSBD00800LT GSBD00800W	Engine Generators
GSBD01000S, GSBD01000L, GSBD01000W	Engine Generators
GSBD01300S, GSBD01300L, GSBD01300W	Engine Generators
GSBD01500S, GSBD01500L, GSBD01500W	Engine Generators
GSBD01700S, GSBD01700L, GSBD01700W, GSBD01750S, GSBD01750L	Engine Generators
GSBD01800S, GSBD01800L	Engine Generators
GSBD02000S, GSBD02000L	Engine Generators
GSBD02300S, GSBD02300L	Engine Generators
GSBD02500S, GSBD02500L	Engine Generators
GSBD02640S, GSBD02640L	Engine Generators
GSBD02800S, GSBD02800L	Engine Generators
GSBD03000S, GSBD03000L	Engine Generators
GSBD03300S, GSBD03300L	Engine Generators
GSBD30600S, GSBD30600L, GSBD30600LT GSBD30600W	Engine Generators
GSBD30633S, GSBD30633L, GSBD30633LT GSBD30633W	Engine Generators
GSBD30644S, GSBD30644L, GSBD30644LT GSBD30644W	Engine Generators

Deborah Jennings-Conner
Deborah Jennings-Conner, VP Regulatory Services



UL LLC

Any information and documentation involving UL Mark services are provided on behalf of UL LLC (UL) or any authorized licensee of UL. For questions, please contact a local UL Customer Service Representative at <http://ul.com/aboutul/locations/>

CERTIFICATE OF COMPLIANCE

Certificate Number MH63698
Report Reference MH63698-20200103
Issue Date 2020-JANUARY-08

Issued to: IGSA S A DE C V
PROLONGACION PASEO DE LA REFORMA 2977
COL CUAJIMALPA
05000 MEXICO
DF MEXICO

This certificate confirms that representative samples of SPECIAL-PURPOSE TANKS
Secondary Containment Generator Base Tanks

Have been investigated by UL in accordance with the Standard(s) indicated on this Certificate.

Standard(s) for Safety: UL 142, STANDARD FOR STEEL ABOVEGROUND TANKS FOR FLAMMABLE AND COMBUSTIBLE LIQUIDS.
UL 142A STANDARD FOR SPECIAL PURPOSE ABOVEGROUND TANKS FOR SPECIFIC FLAMMABLE OR COMBUSTIBLE LIQUIDS.
CAN/ULC S601, STANDARD FOR SHOP FABRICATED STEEL ABOVEGROUND TANKS FOR FLAMMABLE AND COMBUSTIBLE LIQUIDS.

Additional Information: See the UL Online Certifications Directory at <https://iq.ulprospector.com> for additional information.

This *Certificate of Compliance* does not provide authorization to apply the UL Mark. Only the UL Follow-Up Services Procedure provides authorization to apply the UL Mark.

Only those products bearing the UL Mark should be considered as being UL Certified and covered under UL's Follow-Up Services.

Look for the UL Certification Mark on the product.



Bruce Mahrenholz, Director North American Certification Program
UL LLC

Any information and documentation involving UL Mark services are provided on behalf of UL LLC (UL) or any authorized licensee of UL. For questions, please contact a local UL Customer Service Representative at <http://ul.com/aboutul/locations/>

