



**DATA SHEET DIESEL
GENERATOR SET** 

GSBD30644W-UL



► Model

GSBD30644W-UL

- ENGINE BRAND >> BAUDOUIN
- ENGINE MODEL >> 6MM33G12D2/6
- ALTERNATOR BRAND >> WEG
- GENERATOR CONTROLLER >> DSE 7310

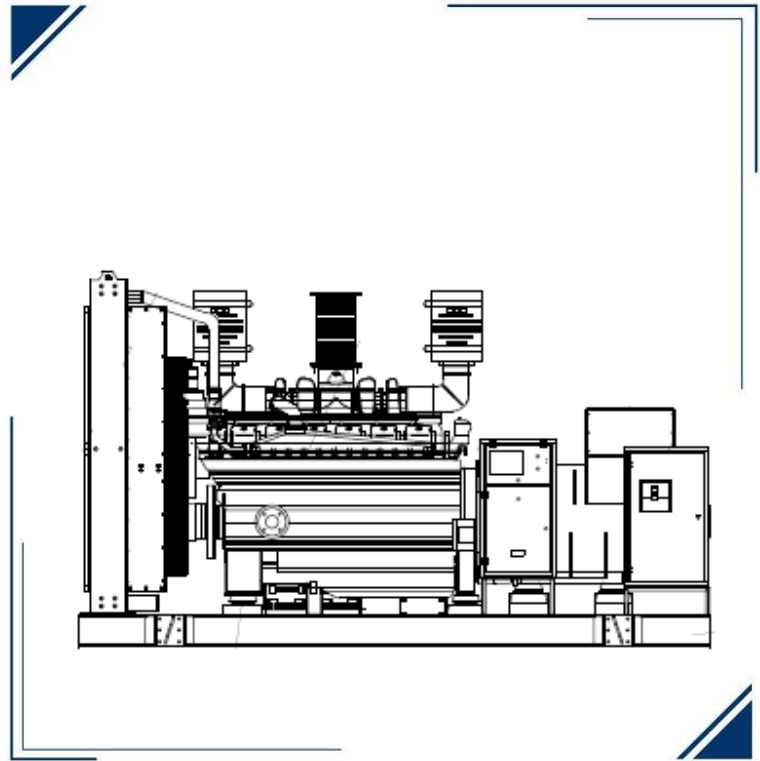

► GENSET RATING

ENGINE	ALTERNATOR	VOLTAGE	PH	Hz	STANDBY POWER		POWER FACTOR	CURRENT
		V			kW	KVA		A
	AG10315MI30AI	208/120	3	60	644	805	0.8	2237
6M33G12D2/6	AG10315MI30AI	480/277	3	60	644	805	0.8	969
	AG10315MI20FI	600/346	3	60	644	805	0.8	775

► Certifications



Standby Power. Applicable for supplying power to varying electrical load for the duration of power interruption of a reliable utility source. Emergency Standby Power (ESP) is in accordance with ISO 8528. Fuel Stop power in accordance with ISO 3046, AS 2789, DIN 6271 and BS 5514.

▶ ENGINE FEATURES

» BRAND _____	▶ BAUDOUIIN
» MODEL _____	▶ 6M33G12D2/6
» EXHAUST EMISSIONS _____	▶ TIER 3
» RPM _____	▶ 1800
» STANDBY RATING kWm _____	▶ 726
» STANDBY RATING bhp _____	▶ 974
» PRIME RATING kWm _____	▶ 680
» PRIME RATING bhp _____	▶ 912
» NUMBER OF CYLINDERS _____	▶ 6
» ASPIRATION _____	▶ TURBOCHARGED AND AFTERCOOLED
» DISPLACEMENT in ³ _____	▶ 1196.1
» ENGINE AIR FLOW CFM (m ³ /min) _____	▶ 1988.21
» GOVERNOR TYPE _____	▶ ELECTRONIC
» CONTROL VOLTAGE v _____	▶ 24
» BORE/STROKE, in _____	▶ 5.9X7.2(150X185)
» COOLANT CAPACITY WITHOUT RADIATOR gal _____	▶ 11.6
» OIL CAPACITY, TOTAL gal _____	▶ 16.9

▶ FUEL CONSUMPTION

STANDBY POWER		
LOAD	GAL/hr	L/hr
100%	48.9	185
75%	35	132.4
50%	23.8	90.2
25%	13.4	50.9

▶ ALTERNATOR FEATURES

» BRAND _____	▶ WEG
» MODEL _____	▶ AG10315MI20FI /AG10315MI30AI
» FREQUENCY _____	▶ 60 Hz
» PHASES _____	▶ 3
» WINDING LEADS _____	▶ 12
» INSULATION SYSTEM _____	▶ H CLASS
» CONTROL SYSTEM _____	▶ BRUSHLESS WITH AUXILIARY COIL
» PROTECTION _____	▶ IP23
» POWER FACTOR _____	▶ 0.8
» COOLING AIR CFM _____	▶
» VOLTAGE REGULATION (%) _____	▶ +- 3

► GENERATOR CONTROLLER

» MODEL

DEEP SEA 7310

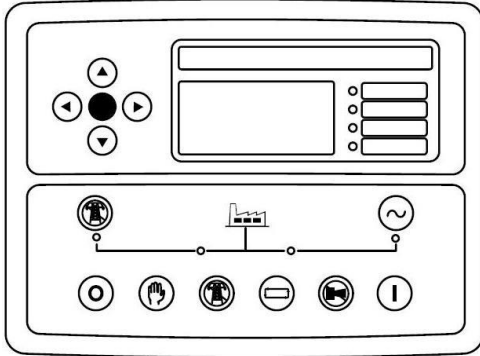

The DSE7310 MKII is an Auto Start Control Module and the DSE7320MKII is an Auto Mains (Utility) Failure Control Module suitable for a wide variety of single, diesel or gas, gen-set applications.

Monitoring an extensive number of engine parameters, the modules will display warnings, shutdown and engine status information on the back-lit LCD screen, illuminated LEDs, remote PC and via SMS text alerts (with external modem). The DSE7320 MKII will also monitor the mains (utility) supply. The modules include USB, RS232 and RS485 ports as well as dedicated DSENet@ terminals for system expansion.

KEY FEATURES

- 4-Line back-lit LCD text display
- Multiple Display Languages
- Five key menu navigation
- LCD alarm indication
- DSENet expansion compatibility
- Internal PLC editor
- Protections disable feature
- Fully configurable via PC using USB, RS232 & RS485 communication
- Front panel configuration with PIN protection
- Power save mode
- 3 phase generator sensing and protection
- 3 phase mains (utility) sensing and protection (DSE7320 MKII only)
- Automatic load transfer control (DSE7320 MKII only)
- Generator current and power monitoring (kW, kvar, kVA, pf)
- Mains current and power monitoring (kW, kvar, kVA, pf) (DSE7320 MKII only)
- kW and kvar overload and reverse power alarms

- Over current protection
- Unbalanced load protection
- Independent earth fault protection
- Breaker control via fascia buttons
- Fuel and start outputs configurable when using CAN
- 6 configurable DC outputs
- 2 configurable volt-free relay outputs
- 6 configurable analogue/digital inputs
- Support for 0 V to 10 V & 4 mA to 20 mA sensors
- 8 configurable digital inputs
- Configurable 5 stage dummy load and load shedding outputs
- CAN, MPU and alternator frequency speed sensing in one variant
- Real time clock
- Manual and automatic fuel pump control
- Engine pre-heat and post-heat functions
- Engine run-time scheduler
- Engine idle control for starting & stopping
- Fuel usage monitor and low fuel level alarms
- Simultaneous use of RS232 and RS485 communication ports
- True dual mutual standby using RS232 or RS485 for accurate engine hours balancing.
- MODBUS RTU support with configurable MODBUS pages.
- Advanced SMS messaging (additional external modem required)
- Start & stop capability via SMS messaging
- 3 configurable maintenance alarms
- Compatible with a wide range of CAN engines, including tier 4 engine support

- Uses DSE Configuration Suite PC Software for simplified configuration
- Licence-free PC software
- IP65 rating (with supplied gasket) offers increased resistance to water ingress
- Modules can be integrated into building management systems (BMS) using MODBUS RTU

KEY BENEFITS

- Automatically transfers between mains (utility) and generator (DSE7320 MKII only) for convenience.
- Hours counter provides accurate information for monitoring and maintenance periods
- User-friendly set-up and button layout for ease of use
- Multiple parameters are monitored & displayed simultaneously for full visibility
- The module can be configured to suit a wide range of applications for user flexibility
- PLC editor allows user configurable functions to meet user specific application requirements.

► DIMENSIONS AND WEIGHT

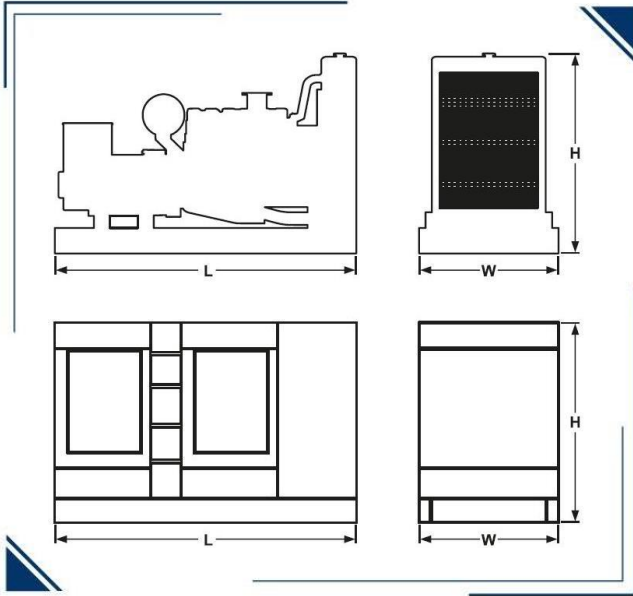

OPEN GENSET					
DIMENSION	Length (L)	Width (W)	Height (H)	Weight	Noise Level
	IN			Lbs	dB
	142	79	87		
ENCLOSED GENSET LEVEL 2					
DIMENSION	Length (L)	Width (W)	Height (H)	Weight	Noise Level
	IN			Lbs	dB
	209	79	98		

► ACOUSTIC ENCLOSURE

Acoustic enclosure designed and manufactured with 14 gauge carbon steel sheet, polyurethane acoustic coating, access and air expulsion to avoid gas accumulation, drainage system to avoid liquid accumulation. Electrostatic painting for extended life. We have options for enclosures in aluminum or stainless steel

► STANDARD FEATURES & ACCESSORIES

<input checked="" type="checkbox"/>	DSE 9470 Battery Charger	<input checked="" type="checkbox"/>	Emergency Stop Button
<input checked="" type="checkbox"/>	Battery and Battery Rack	<input checked="" type="checkbox"/>	Flex Fuel Lines
<input checked="" type="checkbox"/>	ABB Main Line Circuit Breaker	<input checked="" type="checkbox"/>	Protection Covers for Rotating Parts
<input checked="" type="checkbox"/>	OPT-06 AVR	<input checked="" type="checkbox"/>	Exhaust Insulation Cover
<input checked="" type="checkbox"/>	Hotstart Pre heater RMP-CSM10602-000	<input checked="" type="checkbox"/>	Anti Vibration Pads between Engine/Alternator & Base Frame
<input checked="" type="checkbox"/>	Residential Grade Silencer Open Unit	<input checked="" type="checkbox"/>	Operation and Maintenance manuals
<input checked="" type="checkbox"/>	Critical Grade Silencer Inside Enclosure	<input checked="" type="checkbox"/>	24 Months /1000 hours Limited Standby Warranty



▶ OPTIONAL ACCESSORIES

Paralleling Adder (DSE8610 & Motorized Breaker)	Enclosure AC light and On/Off Switch
120V GFCI Receptacle	Enclosure DC light and On/Off Switch
240V Receptacle	Enclosure space Heater (1500w/120v)
Alternator Strip Heater	Load Center / Distribution Board (100 A, 12 Breaker)
Battery Blanket Heater	Load Center / Distribution Board (200 A, 8 Breaker)
Battery Disconnect Switch	AVR UPGRADE
Battery Pad Heater	Oil Pan Heater
Battery Restraint	Relay - 10A Common Alarm
Control Panel Heater	Relay - 10A Run Relay
DSE2157 Output Module (8 dry contacts)	Remote E-Stop- Breaker Glass Type / Nema 3R
DSE2520 Remote Display Module	Remote E-Stop- Breaker Glass Type / Nema 4X
DSE2548 Remote Annunciator (16 light)	Remote E-Stop- Flush Mount
DSE2548 Remote Annunciator (24 light)	Remote E-Stop- Surface Mount
DSE2548 Remote Annunciator (8 light)	Remote E-Stop- Visual/ Plastic Hinged Cover
DSE890 3G GATEWAY	Spring Isolator- Non Seismic (ACE 121 Series) <small>SKIRT NOT INCLUDED</small>
GSM/GPS ANTENNA 3M RG-174, GSM-SMA(M), GPS-SMA(F)	Spring Isolator- Seismic/Restraint (ACE 821 Series) <small>SKIRT NOT INCLUDED</small>
DSE9641 10A Battery Charger	Voltage Adjust Rheostat
DSE9470 10A Battery Charger	Automatic Transfer Switch

▶ OPTIONAL UL142 SUB BASE TANK

	24 hr	48 hr	72 hr
Fuel Capacity (gal)			
Dimensions (L/W/H) in	1300	2600	3700
Weight lb			



IGSA CORP.
5918 Santa Ave
Laredo, Texas 78041
Tel. +1 956.7914.472

www.igsapower.com

	Model :	6M33G12D2/6	Date :	30/11/22
	PowerKit Engine Datasheet		Page :	1 / 4

Ratings

RPM	Gross Engine Output				Net Engine Output			
	PRP		ESP		PRP		ESP	
	kWm	BHP	kWm	BHP	kWm	BHP	kWm	BHP
1800	680 *	912 *	726	974	652 *	874 *	698	936

1 kWm = 1,34102 BHP

When the engine is used with a cooling system using an electrically driven fan, net engine output data may change and quoted figures should be used for reference only

Basic data

Engine model	6M33G12D2/6
N° of Cylinders / Valves	6 / 24
Cylinders arrangement	In line
Bore x Stroke (mm)	150 x 185
Displacement (L)	19.6
Thermodynamic Cycle	Diesel 4 stroke
Firing Order	1-5-3-6-2-4
Mean Piston Speed (m/s)	11.1
BMEP @ ESP (Bar)	24.69
Cooling System	Liquid (water + 50% antifreeze)
Injection System	Direct
Fuel System	High Pressure Common Rail
Aspiration	Turbocharged and Aftercooled
Compression ratio	15 : 1
Flywheel housing	SAE 1
Flywheel	14"
Rotation Viewed from Flywheel...	Counterclockwise
Allowed static bending moment of the flywheel housing...../	
N° of teeth on flywheel ring gear	178
Inertia of flywheel (kg•m ²)	4.76
Inertia of crankshaft (kg•m ²)	2.22
Emission standard	EPA Tier2
Overall Dimensions with radiator (Length x Width x Height) (mm)	2798 x 1680 x 1954
Engine dry weight without radiator and without radiator pipes (kg)	2110
Engine dry weight with radiator and radiator pipes (kg)	2472
Engine wet weight with radiator (includes oil, coolant) (kg)	2689

* The indicated PRP Power is for reference only. This engine is designed for emergency standby power (ESP) applications only.

	Model :	6M33G12D2/6	Date :	30/11/22
	PowerKit Engine Datasheet		Page :	2 / 4

Air intake system

Air intake temperature rise (°C)	≤ 5
Air intake restriction clean filter (mBar)	≤ 30
Air intake restriction dirty filter (mBar)	≤ 65
Recommended air flow @ PRP (m³/min)	53.6
Recommended air flow @ ESP (m³/min)	56.3
Min. diameter of intake pipe (mm)	140

Aftercooling system

Aftercooler system type	Air to Air
Max. intake temperature @ 25°C ambient temperature (°C)	55
Max. difference between intake temperature and ambient temperature (°C)	30
Max. intake pressure drop of aftercooler (mBar)	150

Lubrication system

Oil capacity Low / High (L)	36 / 61
Oil pressure in normal condition idle speed (Bar)	≥ 2
Oil pressure in normal condition at 1800 Rpm @ PRP (Bar)	4 - 6.5
Lowest oil pressure alarm (shutdown) (Bar)	2
High Oil Pressure Warning	10
Max. oil temperature (°C)	105
Oil flow at 1800 Rpm (L/min)	≥ 316
Oil fuel consumption ratio based on engine fuel consumption data	≤ 0.3 %
Total system capacity (including filters) (L)	64

Heat balance test data (with ambient temperature 23 °C)

Total heat dissipation @ ESP (kJ/s)	1275
- Heat Rejection to Jacket Water @ ESP (kJ/s)	385
- Heat Rejection to AfterCooler @ ESP (kJ/s)	224
- Radiated Heat to Ambient @ ESP (kJ/s)	85
- Heat Rejected to Exhaust @ ESP (kJ/s)	581

Exhaust system

Max. exhaust back pressure (mBar)	75
Max. exhaust temperature before turbocharger (°C)	730
Max. exhaust temperature after turbocharger (°C)	550
Exhaust flow @ PRP (m³/min)	160.7
Exhaust flow @ ESP (m³/min)	176.8
Min. diameter of exhaust pipe (mm)	200
Max. bending moment of exhaust gas exit flange (Nm)	10

	Model :	6M33G12D2/6	Date :	30/11/22
	PowerKit Engine Datasheet		Page :	3 / 4

Cooling system with standard radiator

System designed for ambient temperature up to (°C) ¹	50
Radiator type	Mechanical
Fan type	Belt driven pusher
Min. inside diameter of coolant outlet pipe (mm)	84
Coolant capacity of radiator and pipes (L)	115
Coolant alarm (shutdown) temperature (°C)	108
Thermostat opening temperature / full open temperature (°C)	80 / 92
Max. additional restriction for external cooling circuit (Bar)	0.46
Coolant capacity of the engine (L)	44
Cooling fan airflow (m ³ /min)*	1001
Fan absorbed power (kW)	26.8
Additional restriction (for reference) - Duct allowance (Pa)	100

* Air flow figure assumes the presence of the standard radiator provided, taking into consideration the backpressure caused

Fuel system

Governor	ECU
Governor steady state speed stability at constant load (ISO 8528-5 Class G3) ²	≤ +/- 0.5 %
Max. restriction at fuel inlet (Bar)	0.5
Max. pressure at fuel inlet (Bar)	1.3
Max. fuel return restriction (Bar)	0.5
Max. fuel inlet temperature (°C)	50
Fuel supply flow (L/hr)	950
Min. internal diameter of inlet pipe (mm)	14
Min. internal diameter of return pipe (mm)	14

Electrical system

Electrical system voltage (negative to ground) (Vdc)	24
Starter power (kW)	8.5
Battery charger current (A)	55
Battery charger absorbed power (kW)	1.6
Max. electric resistance of starting circuit (Ω)	0.008
Min. sectional area of wire (mm ²)	70
Min. cold start temperature without auxiliary starting device (°C) ³	- 5
Min. cold start temperature with auxiliary starting device (°C) ³	- 10

¹ The indicated value is based on the AOT value of 50°C for an engine tested at 100% of the ESP Power, reflecting temperature in an open condition, without an enclosure or container, without any airflow obstruction in the front of the radiator, without air recirculation, with free exhaust gas exit and with the engine thermostatic valve in its full open condition, without a closing plate present. The reference air restriction is equal to 50Pa. For the equivalent ATB (Air-to-Boil) performance in a customer or project basis, please consult Baudouin Application Engineering.

² This refers only to the frequency response of the engine and should not be confused with the performance class of the Generator Set, which is subject to additional contributing factors such as alternator selection and control settings.

³ Engines used in emergency standby application or applications that require immediate start under load, they must be equipped with coolant heaters. Baudouin recommend heaters installation to be executed by providing constant coolant circulation across all the engine components. Two heaters are required for V-type engines, one per each side.

	Model : 6M33G12D2/6	Date : 30/11/22
	PowerKit Engine Datasheet	Page : 4 / 4

Noise

Diesel engine noise (Acoustic power level) (dB(A))	121.3
Noise - upper side (dB(A))	104.2
Noise - right side (view from flywheel) (dB(A))	105.6
Noise - left side (view from flywheel) (dB(A))	105.6
Noise – front (radiator) side (dB(A))	103.7
Noise – rear (flywheel) side (dB(A))	104

Notes :

- Noise test made at 100% of the ESP power, at 1 mt. distance, on engine without radiator, without cooling fan and without silencer.
- Noise test refers to ISO 6798 norm : “Reciprocating internal combustion engines. Measurement of emitted airborne noise. Engineering method and survey method”.

Fuel consumption

Rating	gr/kWh	L/hr
100% ESP	214	185
100% PRP	214	173.2
75% PRP	218.1	132.4
50% PRP	222.9	90.2
25% PRP	251.5	50.9
Fuel consumption tolerance +/- 5%		

Notes:

This engine is designed for ESP (Emergency Standby) applications only, the values shown above at PRP levels refer to the Referenced Power (680 kWm).

Ratings definitions

Emergency Standby Power (ESP)

Emergency Standby Power is the maximum power available for a varying load for the duration of a main power network failure. The average load factor over 24 hours of operation should not exceed 70% of the engine’s ESP power rating. Typical operational hours of the engine is 200 hours per year, with a maximum usage of 500 hours per year. This includes an annual maximum of 25 hours per year at the ESP power rating. No overload capability is allowed. The engine is not to be used for sustained utility paralleling applications.

Prime Power (PRP)

Prime Power is the maximum power available for unlimited hours of usage in a variable load application. The average load factor should not exceed 70% of the engine’s PRP power rating during any 24 hour period. An overload capability of 10% is available, however, this is limited to 1 hour within every 12 hour period.

- All ratings are based on operating conditions under ISO 8528-1, ISO 3046, DIN6271. Performance tolerance of $\pm 5\%$.
- Test conditions : 100 kPa, 25°C air inlet temperature, relative humidity of 30%, with fuel density 0.84 kg/L. Derating may be required for conditions outside these; please contact the factory for details.
- Power output curves are based on the engine operating with fuel system, water pump and lubricating oil pump; not included are battery charging alternator, fan and optional equipment.

HOJA DE DATOS

Alternadores Sincrónicos



Cliente	:	Notas:
Referencia del cliente	:	
Línea del producto	: AG10-315MI30AI	Código del producto : 14419208
Clasificación de área	: Segura	1010276767

Datos generales		Grado de protección	: IP23
Carcasa (IEC)	: 315	Forma constructiva	: B35T
Clase de aislamiento	: 180°C (H)	Polos - Tipo de polos	: 4
Distorsión armónica total (sin carga) (%)	: ≤ 3%	Tipo de polo	: Saliente
Paso del bobinado del estator principal	: 2/3	Rotación (rpm) - 50Hz	: 1500 rpm
Altitud	: hasta 1000 m	Rotación (rpm) - 60Hz	: 1800 rpm
Número de Terminales	: 12	Sobrevelocidad (rpm)	: 2250 rpm
Factor de potencia	: 0.8 hasta 1.0	Masa del alternador	: 1576 kg
Sistema de excitación	: Brushless con bobina auxiliar	Sobrecarga	: 1.1x In por 1h cada 6h
Refrigeración	: IC01	Sobrecarga Momentánea	: 1.5x In por 30s

Frecuencia y número de fases	50 Hz				60 Hz										
	Trifásico		Monofásico	Trifásico		Monofásico									
Tensión (V)	Conexión Y		380	400	-	380	440	480	-						
	Conexión YY		190	200	-	190	220	240	-						
	Conexión Δ		220	230	-	220	254	277	-						
	Conexión ΔΔ		110	115	-	110	127	138	-						
	Zig-zag paral o triáng monof.		-	-	-	190 - 200	-	-	220 - 240						
Potencias (kVA)	Continuo 80/40		600	600	346	608	672	740	388						
	Continuo 105/40		687	687	397	710	770	850	445						
	Continuo 125/40		750	750	433	760	840	925	485						
	Standby 150/40		822	822	474	810	920	1010	531						
	Standby 163/27		856	856	495	868	958	1056	553						
Datos eléctricos (FP=0.8 / continuo 125/40 (H))	Xd(%) React. síncronica eje directo		132.9	106.9	177.2	266.9	247.6	133.6	330.2						
	X'd(%) React. trans. de eje directo		13.2	11.6	17.6	22.7	17.2	14.9	22.9						
	X''d(%) React. subtrans. eje directo		9.7	8.3	12.9	16.8	12.5	10.7	16.7						
	Xq(%) React. sinc. eje en cuadratura		43.5	32.7	58.0	126.5	61.2	50.4	81.6						
	X''q(%) React. subt. eje en cuadratura		7.8	8.3	10.3	15.7	9.5	9.8	12.6						
	X2(%) React. sec. neg. eje cuadratura		8.7	8.3	11.6	16.2	11.0	10.2	14.6						
	X0(%) React. secuencia cero saturada		1.6	1.4	2.1	2.8	2.1	1.8	2.8						
	T'd(ms) Cte trans. eje dir. C. Circ.		136.2	131.1	181.6	180.1	171.7	157.3	228.9						
	T'do(ms) Cte subt. eje dir. cortocirc		0.6	0.4	0.8	1.4	0.8	0.5	1.1						
	T''do(ms) Cte Trans circ. abierto sat.		1386	1225	1847	2142	1826	1471	2435						
	T''do(ms) Cte subtrans. circ abierto		1.6	1.5	2.1	2.1	2.0	1.8	2.6						
	Ta(ms) Cte cortocirc. armadura		12	10	15	20	15	13	20						
	uc(V) Voltaje excitación nominal		70.0	68.0	70.0	67.0	65.0	70.0	65.0						
	ic(A) Corriente de excitación nominal		3.5	3.4	3.5	2.8	3.1	3.5	3.1						
	ic(A) Corriente excitación sin carga		1.1	0.9	1.5	0.5	0.9	1.4	1.2						
	Icc(A) Corriente mantenim. de cortoc.		3419	3248	3248	3464	3307	3338	3031						
	Kcc Relación de cortocircuito		0.5	0.63	0.67	0.42	0.58	0.76	0.77						
Rendimientos (%)	Factor de potencia	0.8	1.0	0.8	1.0	0.8	1.0	0.8	1.0	0.8	1.0				
	25% de carga	90.3	92.4	89.5	91.8	83.1	85	91.9	93.6	91	92.9	90.4	92.5	83.7	85.4
	50% de carga	93.6	95.2	93.2	94.9	86.1	87.6	94.6	95.9	94.1	95.6	93.9	95.4	86.6	88
	75% de carga	94.3	95.9	94.1	95.7	86.8	88.2	95.1	96.3	94.6	96.3	94.7	96.2	87	88.6
	100% de carga	94.4	96	94.2	96	86.8	88.3	95	96.3	95.1	96.4	94.9	96.4	87.5	88.7
	125% de carga	94.1	95.9	94	95.9	86.6	88.2	94.7	96.1	94.9	96.4	94.7	96.4	87.3	88.7

Demais características	Flujo de aire	: 2.79 m³/s	Regulador de voltaje	Precisión (estabilidad)	: +/- 0.5%	Conforme normas:	IEC 60034
	Resistencia del estator de la excitatriz a 20°C	: 15.26 ohm		Corriente nominal	: 5 A		NBR 5117
	Resistencia del estator principal a 20°C	: 0.00295 ohm		Entrada analógica	: Sí		NEMA MG1
	Resistencia del rotor	: 2.1 ohm		Entrada digital	: No		VDE530
	Camadas del bobinado del estator	: 2		Corriente de pico	: 7 A/10 s		ISO 8528
	Inercia WR2	: 7.32 kgm²		Droop / TC	: Sí		CSA
	Rodamiento trasero	: 6316 2RS/ZZ		Respuesta dinámica	: 8 hasta 500 ms		
	Rodamiento LA	: 6320 2RS/ZZ		U/F	: Sí		
	Brida	: SAE 1		Ajuste interno de voltaje	: +/- 15%		
	Disco de acoplamiento	: SIN		Ajuste externo de voltaje	: +/- 10%		
				Tiempo de respuesta transitoria para ΔU=20%	: 500 ms		

Rev.	Resumen de los cambios		Ejecutado	Verificado	Fecha
Ejecutor					
Verificador				Pagina	Revisión
Fecha	07/09/2023			1 / 6	

HOJA DE DATOS

Alternadores Sincrónicos

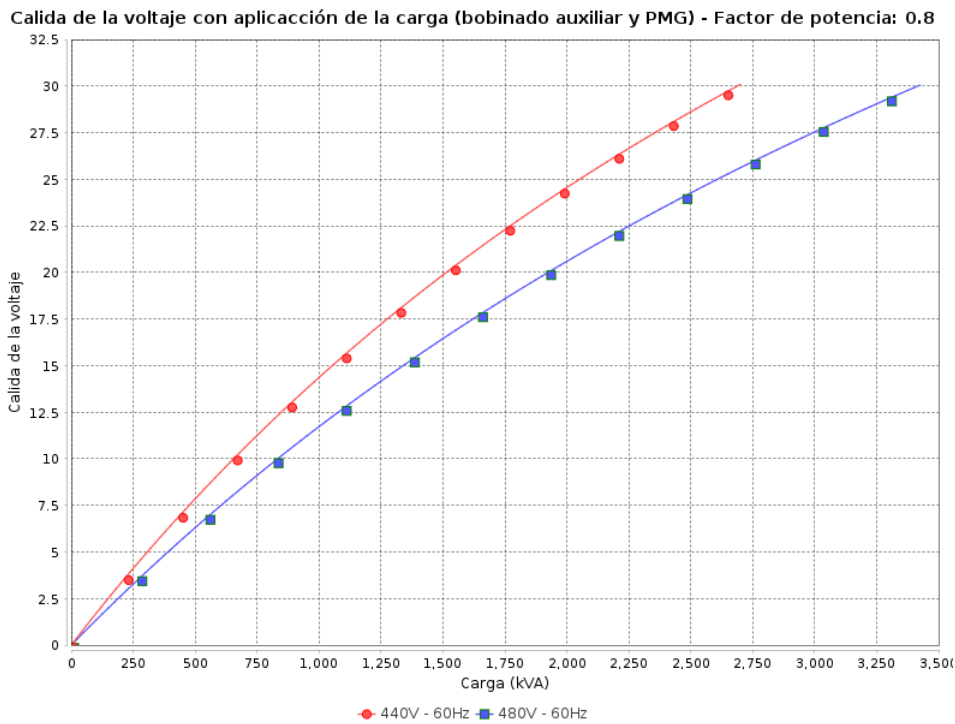
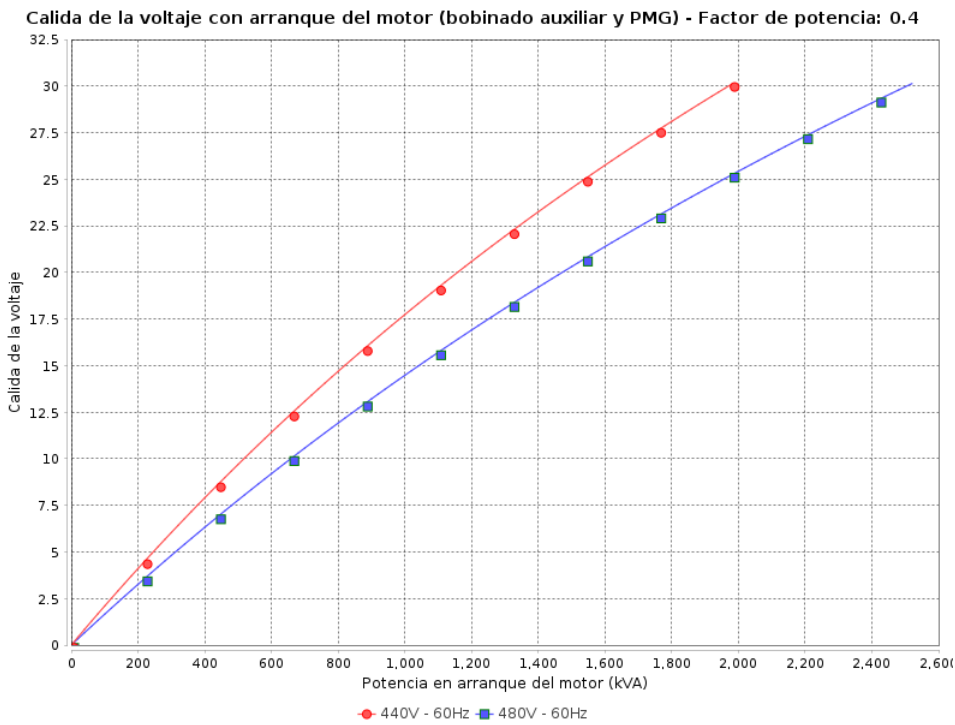

Rev.	Resumen de los cambios	Ejecutado	Verificado	Fecha
Ejecutor				
Verificador			Pagina	Revisión
Fecha	07/09/2023		2 / 6	

HOJA DE DATOS

Alternadores Sincrónicos



Aumento de la voltaje con rechazo de la carga (bobinado auxiliar y PMG) - Factor de potencia: 1.0

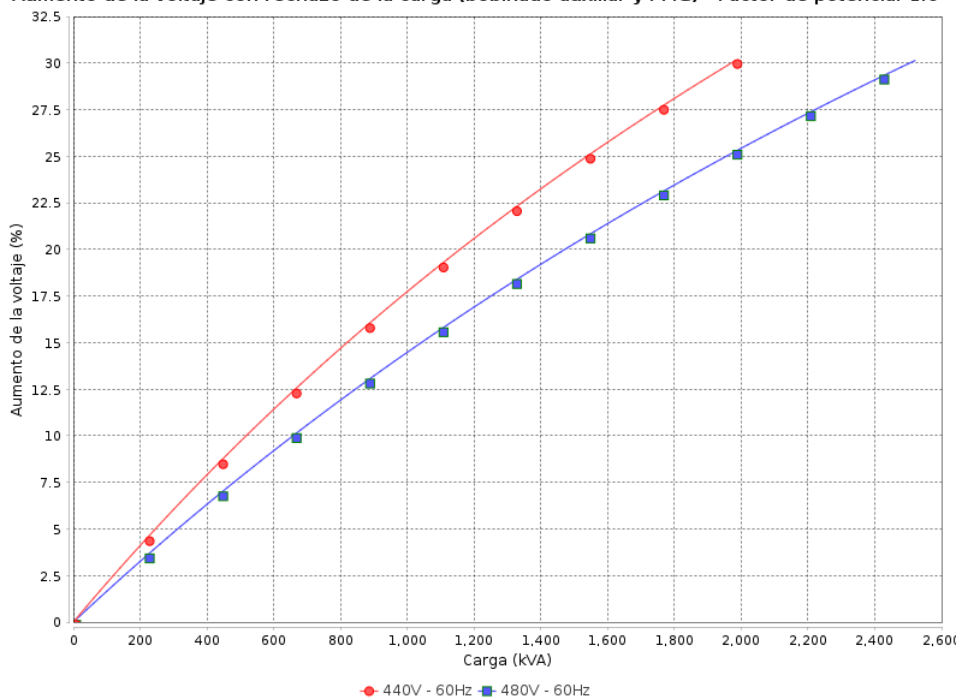

Aplicación de la carga

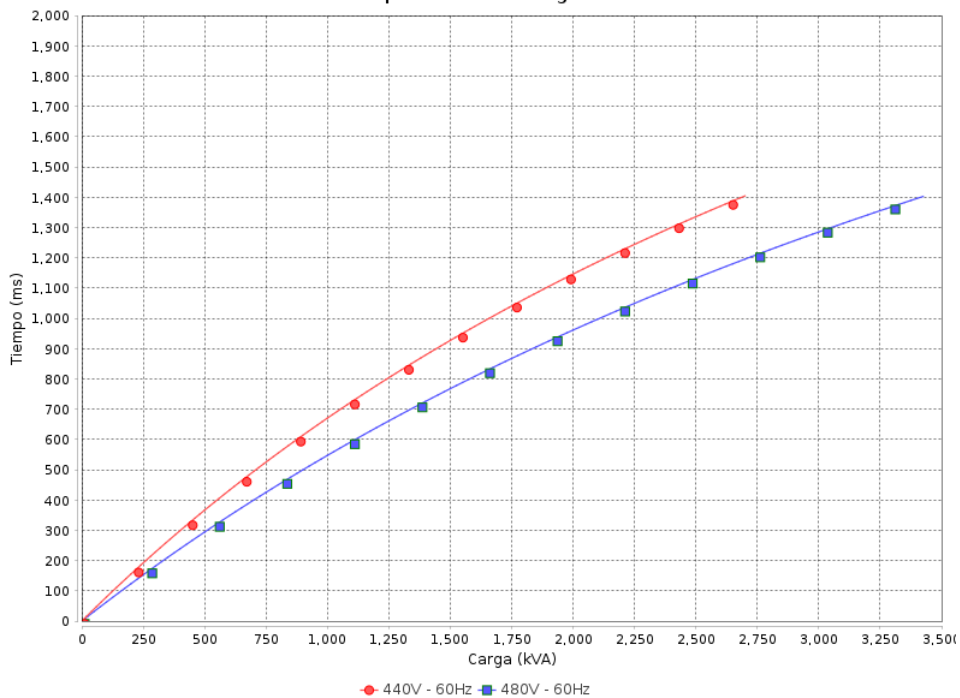

Rev.	Resumen de los cambios	Ejecutado	Verificado	Fecha
Ejecutor			Página	Revisión
Verificador			3 / 6	
Fecha	07/09/2023			

HOJA DE DATOS

Alternadores Sincrónicos

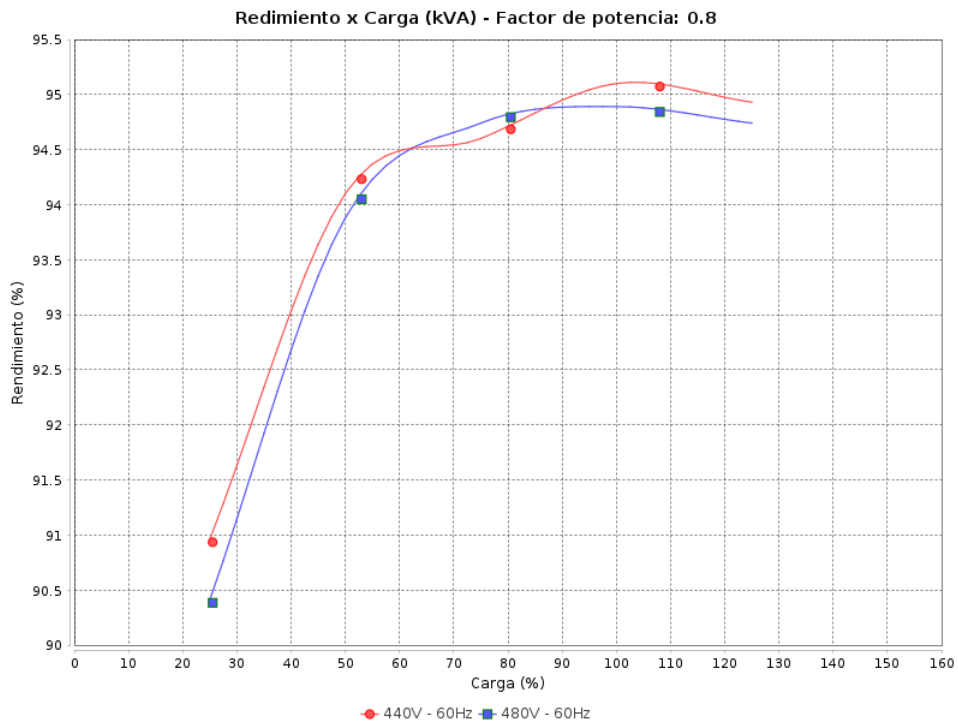
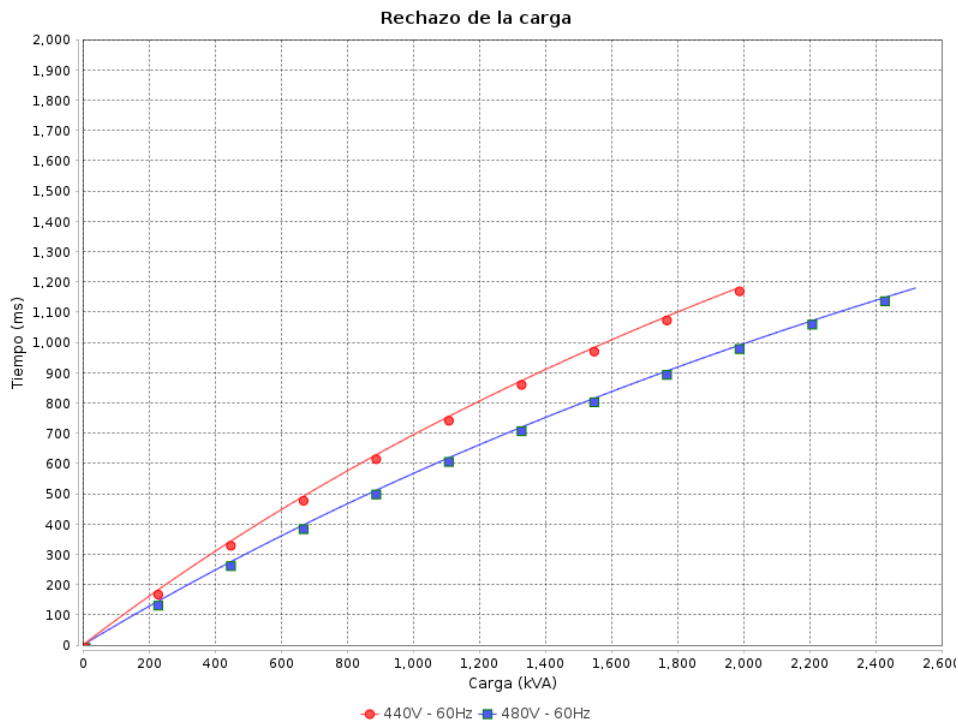

Rev.	Resumen de los cambios	Ejecutado	Verificado	Fecha
Ejecutor			Pagina 4 / 6	Revisión
Verificador				
Fecha	07/09/2023			

HOJA DE DATOS

Alternadores Sincrónicos

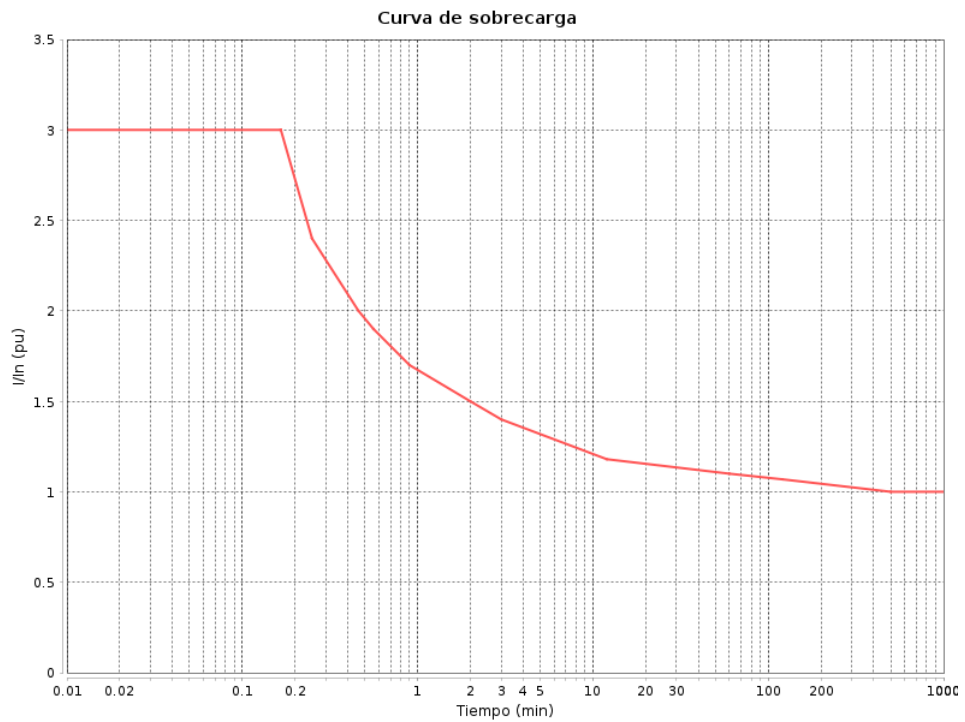
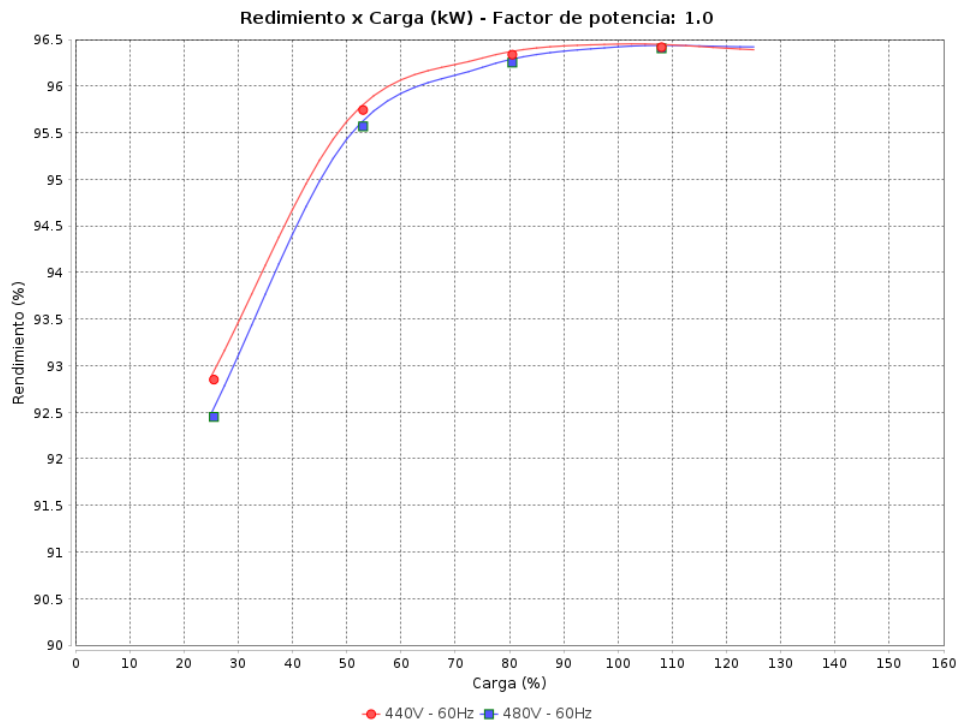

Rev.	Resumen de los cambios	Ejecutado	Verificado	Fecha
Ejecutor				
Verificador			Pagina	Revisión
Fecha	07/09/2023		5 / 6	

HOJA DE DATOS

Alternadores Sincrónicos



Curva de enfriamiento

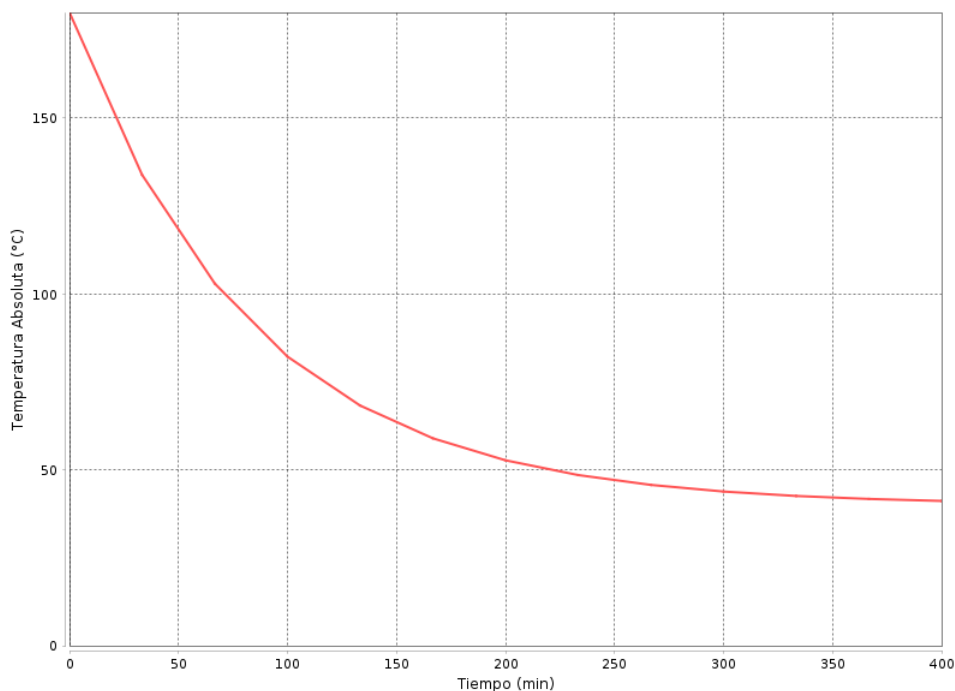

Rev.	Resumen de los cambios	Ejecutado	Verificado	Fecha
Ejecutor		Pagina 6 / 6		Revisión
Verificador				
Fecha	07/09/2023			

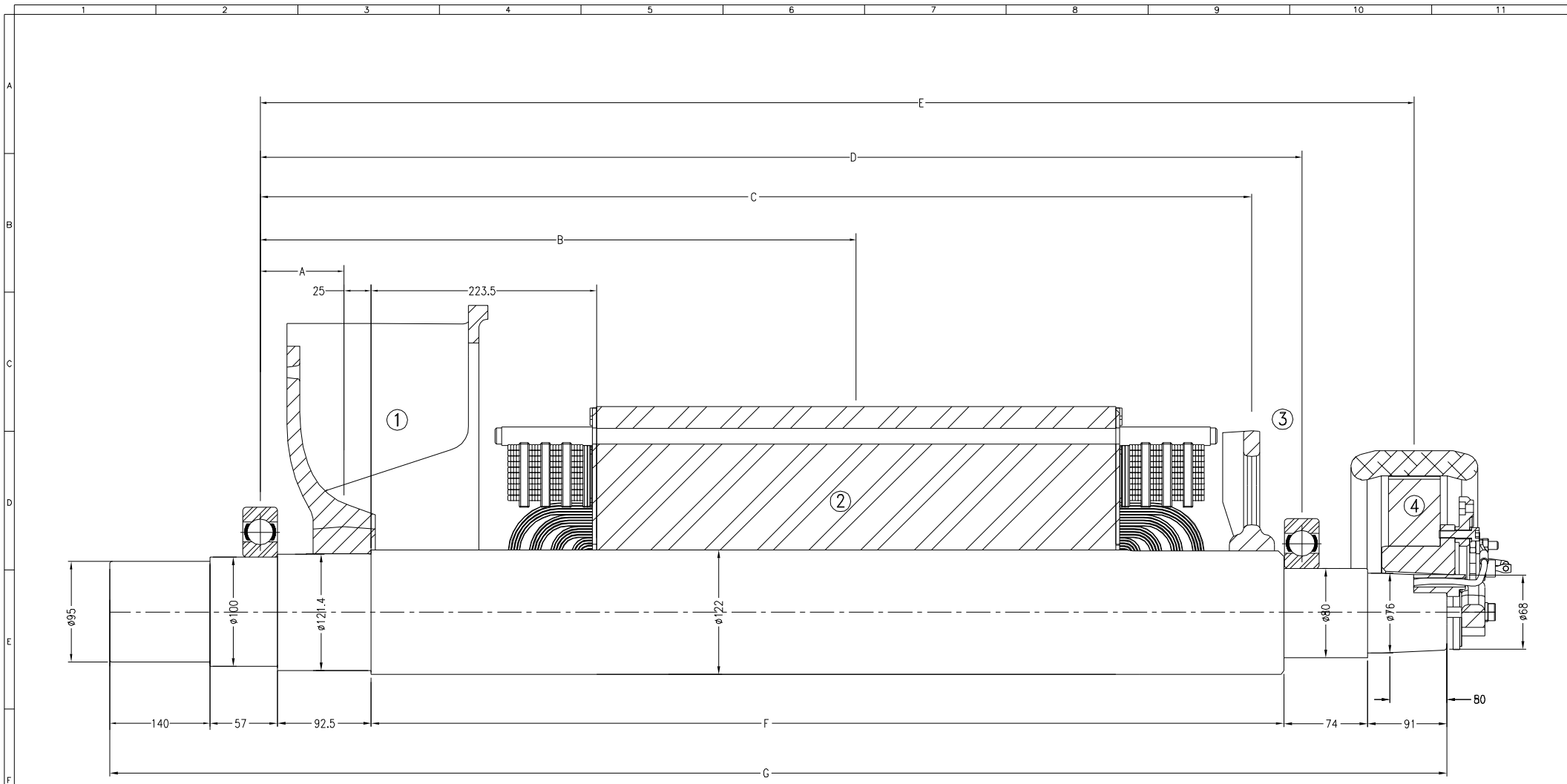

TIPO/AG10 TYPE/AG10	DIMENSÕES: mm / DIMENSIONS: mm							1		2		3		4		Total Weight kg	Total Mam. Iner. J kgm ²		
	A	B	C	D	E	F	G	WEIGHT MASSA kg	MOMENT MOMENTO kgm ²	WEIGHT MASSA kg	MOMENT MOMENTO kgm ²	WEIGHT MASSA kg	MOMENT MOMENTO kgm ²	WEIGHT MASSA kg	MOMENT MOMENTO kgm ²				
315S_10	91.0	489.5	779.5	896.5	1002.0	761.0	1215.5	18.8	0.70	233.2	4.898	11.4	0.169	27.4	0.23	290.8	5.997		
315S_15		529.5	839.5							270.6	5.255					328.2	6.354		
315S_20		529.5	859.5							285.6	5.609					343.2	6.708		
315M_10		495.5	788.7	1026.5	1132.0	891.0	1345.5			252.3	4.641					309.6	5.702		
315M_15		519.5	838.2							281.1	5.197							338.7	6.256
315M_20		544.5	889.5							310.2	5.756							367.8	6.855
315M_30		569.5	939.5							339.3	6.315							396.9	7.414
315M_40		594.5	989.5	368.4	6.874	426.0	7.973												

PESO BRUTO	0.000000	kg	PESO LÍQUIDO	0.000000	kg	ESC.	NDX	1:300
ESC.	LOC	REVISÃO MODIFICAÇÃO	E RECOLTADO	VERIFICADO	LIBERADO	DATA	VE	
REV.	DESIGN	NUMERO DE APROVAÇÃO	EXCETO	CHECO	LIBERADO	DATE	VE	
VPR.	DESIGN	PROJETO FONDAÇÃO AGT 315 B3				10009091317		
LIB.	LIBERADO					000	00	



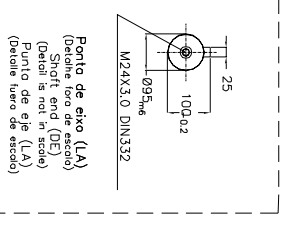
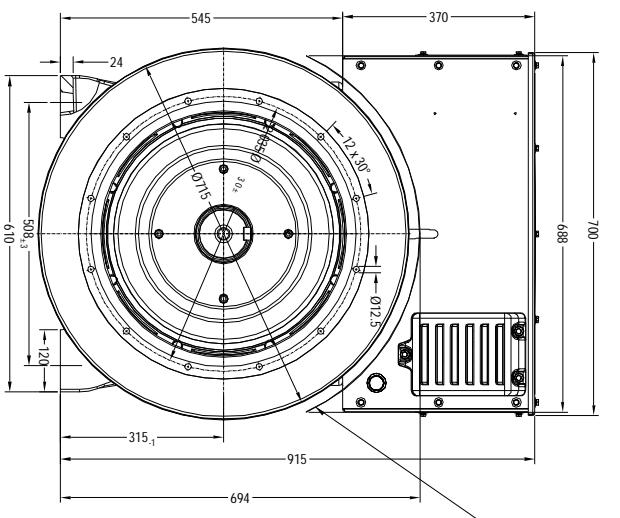
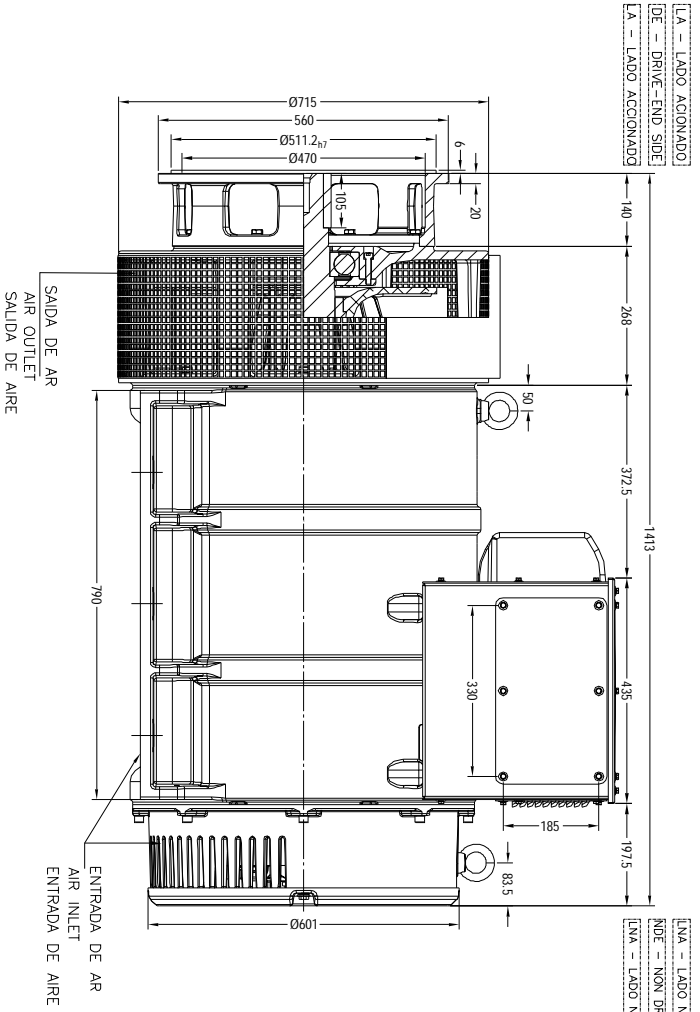

Porta de eixo (L1)
(Detalle toro de escudo)
Shaft end (L1)
(Detail toro de escudo)
Porta de eixo (L1)
(Detalle toro de escudo)

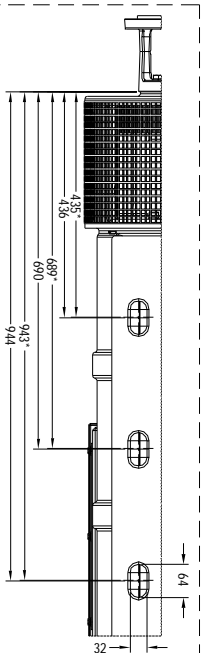

Furo para fixação da máquina
(Detalle toro de escudo)
Mounting Hole
(Detail is not in scale)
Agujero para fijación de la máquina
(Detalle toro de escudo)

*Dimensão recomendada pelo WEG para a função de eixo
*Recommended dimension for mounting hole position on the shaft
*Dimensión recomendada para el montaje del agujero sobre el eje

PESO BRUTO/GROSS WEIGHT		PESO LÍQUIDO/NET WEIGHT		ESC /SCALE		1:10.00	
ECM	LOC	RESUMO MODIFICAÇÃO SUMMARY OF MODIFICATIONS		EXECUTADO EXECUTED	VERIFICADO CHECKED	LIBERADO RELEASED	DATA DATE
EXEC /CHECKED	VERIF /CHECKED	DIMENSIONAL ACIO 315M B35T		000	01		
DATA LIBREL DT 10.07.2017		FOLHA/SHEET 01 / 01		<p>NOTAS / NOTES / NOTAS</p> <p>Máquina / Machine / Máquina : AG10315M - B35T</p> <p>Grau de proteção / Protection / Grado de protección: IP21 / IP23</p> <p>Flange de acoplamento / Coupling flange / Brido de acoplamiento: SAE 1</p>			
Propriedade da WEG. Proibido reprodução sem autorização prévia/WEG's property. Forbidden reproduction without previous authorization.							

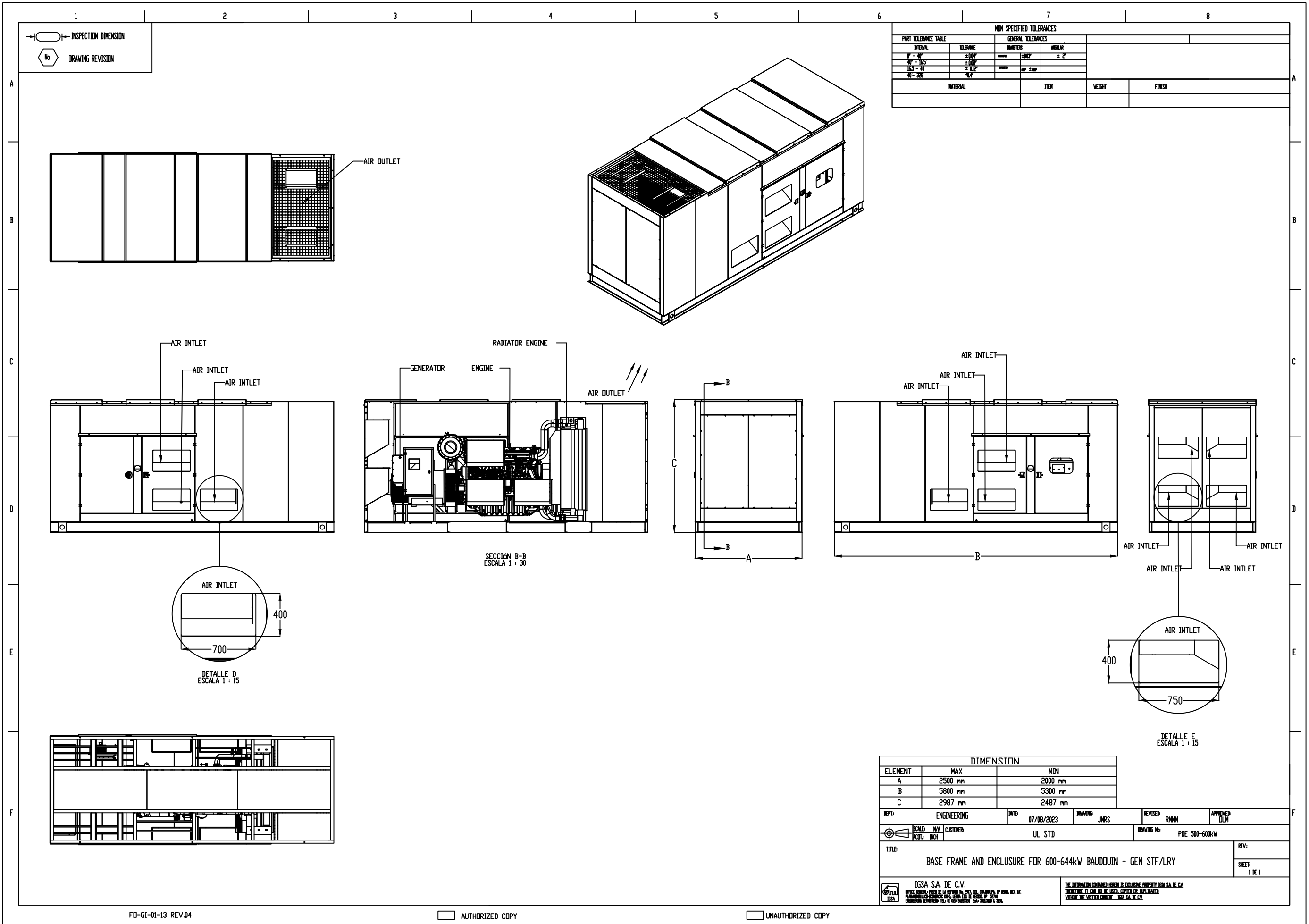

NON SPECIFIED TOLERANCES			
PART TOLERANCE TABLE		GENERAL TOLERANCES	
DIAMETRAL	TOLERANCE	DIMETERS	ANGULAR
0 - 40"	± 0.004"	± 0.004"	± 2°
40" - 16.5"	± 0.005"	± 0.005"	
16.5" - 40"	± 0.006"	± 0.006"	
40" - 320"	± 0.008"	± 0.008"	
MATERIAL	ITEM	WEIGHT	FINISH

DIMENSION		
ELEMENT	MAX	MIN
A	2500 mm	2000 mm
B	5800 mm	5300 mm
C	2987 mm	2487 mm

DEPT:	ENGINEERING	DATE:	07/08/2023	DRAWING:	JMRS	REVISED:	RMMH	APPROVED:	DLH	
SCALE:	N/A	CUSTOMER:	UL STD	DRAWING No:	PDE 500-600kW	REV:				
TITLE:	BASE FRAME AND ENCLASURE FOR 600-644kW BAUDOUIN - GEN STF/LRY								SHEET:	1 DE 1
IGSA SA DE CV. <small>OFFICE: AVENUE PIERRE DE LA FERRONIE 100, MONTRIEUX, SUISSE. TEL: +41 26 300 11 11. FAX: +41 26 300 11 12. WWW.IGSA.CH</small>					<small>THE INFORMATION CONTAINED HEREIN IS EXCLUSIVE PROPERTY OF IGSA SA DE CV. IT IS NOT TO BE REPRODUCED, COPIED, OR DISSEMINATED WITHOUT THE WRITTEN CONSENT OF IGSA SA DE CV.</small>					

CERTIFICATE OF COMPLIANCE

Certificate Number UL-US-2345744-0
Report Reference AU6440-20231107
Date 10-Nov-2023

Issued to: IGSA S A DE C V
PROLONGACION PASEO DE LA REFORMA # 2977
COL CUAJIMALPA
MEXICO, Mexico 05000
Mexico

This is to certify that representative samples of FTSR - Engine Generators
See Addendum Page for Product Designation(s).

Have been evaluated by UL in accordance with the Standard(s) indicated on this Certificate.

Standard(s) for Safety: UL 2200, 2nd Ed., Issue Date: 2012-06-01, Revision Date: 2015-07-29

Additional Information: See the UL Online Certifications Directory at <https://iq.ulprospector.com> for additional information

This Certificate of Compliance indicates that representative samples of the product described in the certification report have met the requirements for UL certification. It does not provide authorization to apply the UL Mark. Only the Authorization Page that references the Follow-Up Services Procedure for ongoing surveillance provides authorization to apply the UL Mark.

Only those products bearing the UL Mark should be considered as being UL Certified and covered under UL's Follow-Up Services.

Look for the UL Certification Mark on the product.

Deborah Jennings-Conner

Deborah Jennings-Conner, VP Regulatory Services

UL LLC

Any information and documentation involving UL Mark services are provided on behalf of UL LLC (UL) or any authorized licensee of UL. For questions, please contact a local UL Customer Service Representative at <http://ul.com/aboutul/locations/>



CERTIFICATE OF COMPLIANCE

Certificate Number UL-US-2345744-0
Report Reference AU6440-20231107
Date 10-Nov-2023

This is to certify that representative samples of the product as specified on this certificate were tested according to the current UL requirements

Model	Category Description
GSBD00700S, GSBD00700L, GSBD00700LT GSBD00700W	Engine Generators
GSBD00800S, GSBD00800L, GSBD00800LT GSBD00800W	Engine Generators
GSBD01000S, GSBD01000L, GSBD01000W	Engine Generators
GSBD01300S, GSBD01300L, GSBD01300W	Engine Generators
GSBD01500S, GSBD01500L, GSBD01500W	Engine Generators
GSBD01700S, GSBD01700L, GSBD01700W, GSBD01750S, GSBD01750L	Engine Generators
GSBD01800S, GSBD01800L	Engine Generators
GSBD02000S, GSBD02000L	Engine Generators
GSBD02300S, GSBD02300L	Engine Generators
GSBD02500S, GSBD02500L	Engine Generators
GSBD02640S, GSBD02640L	Engine Generators
GSBD02800S, GSBD02800L	Engine Generators
GSBD03000S, GSBD03000L	Engine Generators
GSBD03300S, GSBD03300L	Engine Generators
GSBD30600S, GSBD30600L, GSBD30600LT GSBD30600W	Engine Generators
GSBD30633S, GSBD30633L, GSBD30633LT GSBD30633W	Engine Generators
GSBD30644S, GSBD30644L, GSBD30644LT GSBD30644W	Engine Generators

Deborah Jennings-Conner
Deborah Jennings-Conner, VP Regulatory Services



UL LLC

Any information and documentation involving UL Mark services are provided on behalf of UL LLC (UL) or any authorized licensee of UL. For questions, please contact a local UL Customer Service Representative at <http://ul.com/aboutul/locations/>

CERTIFICATE OF COMPLIANCE

Certificate Number UL-CA-2339551-0
Report Reference AU6440-20231107
Date 10-Nov-2023

Issued to: IGSA S A DE C V
PROLONGACION PASEO DE LA REFORMA # 2977
COL CUAJIMALPA
MEXICO, Mexico 05000
Mexico

This is to certify that representative samples of FTSR7 - Engine Generators Certified for Canada
See Addendum Page for Product Designation(s).

Have been evaluated by UL in accordance with the Standard(s) indicated on this Certificate.

Standard(s) for Safety: CSA C22.2 No. 14, Edition 13, Issue Date 2018-03, Revision Date 2022-06

Additional Information: See the UL Online Certifications Directory at <https://iq.ulprospector.com> for additional information

This Certificate of Compliance indicates that representative samples of the product described in the certification report have met the requirements for UL certification. It does not provide authorization to apply the UL Mark. Only the Authorization Page that references the Follow-Up Services Procedure for ongoing surveillance provides authorization to apply the UL Mark.

Only those products bearing the UL Mark should be considered as being UL Certified and covered under UL's Follow-Up Services.

Look for the UL Certification Mark on the product.

Deborah Jennings-Conner, VP Regulatory Services

UL LLC



Any information and documentation involving UL Mark services are provided on behalf of UL LLC (UL) or any authorized licensee of UL. For questions, please contact a local UL Customer Service Representative at <http://ul.com/aboutul/locations/>

CERTIFICATE OF COMPLIANCE

Certificate Number UL-CA-2339551-0
Report Reference AU6440-20231107
Date 10-Nov-2023

This is to certify that representative samples of the product as specified on this certificate were tested according to the current UL requirements

Model	Category Description
GSBD00700S, GSBD00700L, GSBD00700LT GSBD00700W	Engine Generators
GSBD00800S, GSBD00800L, GSBD00800LT GSBD00800W	Engine Generators
GSBD01000S, GSBD01000L, GSBD01000W	Engine Generators
GSBD01300S, GSBD01300L, GSBD01300W	Engine Generators
GSBD01500S, GSBD01500L, GSBD01500W	Engine Generators
GSBD01700S, GSBD01700L, GSBD01700W, GSBD01750S, GSBD01750L	Engine Generators
GSBD01800S, GSBD01800L	Engine Generators
GSBD02000S, GSBD02000L	Engine Generators
GSBD02300S, GSBD02300L	Engine Generators
GSBD02500S, GSBD02500L	Engine Generators
GSBD02640S, GSBD02640L	Engine Generators
GSBD02800S, GSBD02800L	Engine Generators
GSBD03000S, GSBD03000L	Engine Generators
GSBD03300S, GSBD03300L	Engine Generators
GSBD30600S, GSBD30600L, GSBD30600LT GSBD30600W	Engine Generators
GSBD30633S, GSBD30633L, GSBD30633LT GSBD30633W	Engine Generators
GSBD30644S, GSBD30644L, GSBD30644LT GSBD30644W	Engine Generators

Deborah Jennings-Conner

Deborah Jennings-Conner, VP Regulatory Services

UL LLC

Any information and documentation involving UL Mark services are provided on behalf of UL LLC (UL) or any authorized licensee of UL. For questions, please contact a local UL Customer Service Representative at <http://ul.com/aboutul/locations/>



CERTIFICATE OF COMPLIANCE

Certificate Number MH63698
Report Reference MH63698-20200103
Issue Date 2020-JANUARY-08

Issued to: IGSA S A DE C V
PROLONGACION PASEO DE LA REFORMA 2977
COL CUAJIMALPA
05000 MEXICO
DF MEXICO

This certificate confirms that representative samples of SPECIAL-PURPOSE TANKS
Secondary Containment Generator Base Tanks

Have been investigated by UL in accordance with the Standard(s) indicated on this Certificate.

Standard(s) for Safety: UL 142, STANDARD FOR STEEL ABOVEGROUND TANKS FOR FLAMMABLE AND COMBUSTIBLE LIQUIDS.
UL 142A STANDARD FOR SPECIAL PURPOSE ABOVEGROUND TANKS FOR SPECIFIC FLAMMABLE OR COMBUSTIBLE LIQUIDS.
CAN/ULC S601, STANDARD FOR SHOP FABRICATED STEEL ABOVEGROUND TANKS FOR FLAMMABLE AND COMBUSTIBLE LIQUIDS.

Additional Information: See the UL Online Certifications Directory at <https://iq.ulprospector.com> for additional information.

This *Certificate of Compliance* does not provide authorization to apply the UL Mark. Only the UL Follow-Up Services Procedure provides authorization to apply the UL Mark.

Only those products bearing the UL Mark should be considered as being UL Certified and covered under UL's Follow-Up Services.

Look for the UL Certification Mark on the product.



Bruce Mahrenholz, Director North American Certification Program
UL LLC

Any information and documentation involving UL Mark services are provided on behalf of UL LLC (UL) or any authorized licensee of UL. For questions, please contact a local UL Customer Service Representative at <http://ul.com/aboutul/locations/>

